



Three Phase Inverter with SetApp Configuration

Quick Installation Guide

P. 01 > P. 21 > P. 41 >

EN	PL	JP
FR	ES	SE
NL	CHT	CZ
IT	PT	TR
DE	KO	HU

For Europe, APAC and
South Africa
Version 1.0



EN
Scan for accessing
a more detailed
Installation Guide

EN











FR

NL

IT

DE

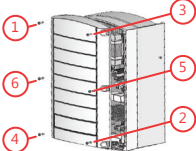
EN LEGEND FR LÉGENDE NL LEGENDA IT LEGENDA DE LEGENDE

 <ul style="list-style-type: none"> EN Note FR Remarque NL Opmerking IT Nota DE Hinweis 	 <ul style="list-style-type: none"> EN Do not cut cable connectors FR Ne pas couper les connecteurs du câble NL Snijd geen connectorkabels door IT Non tagliare i connettori dei cavi DE Steckverbinder nicht abschneiden 	 <ul style="list-style-type: none"> EN <ol style="list-style-type: none"> 1. Turn ON/OFF/P Switch to OFF (0) 2. Turn Safety Switch to OFF 3. Open the six cover screws FR <ol style="list-style-type: none"> 1. Placer le commutateur MARCHE/ARRÊT sur ARRÊT (0) 2. Placer l'interrupteur de sécurité sur ARRÊT 3. Ouvrir les six vis du couvercle NL <ol style="list-style-type: none"> 1. Zet AAN/UIT schakelaar UIT (0) 2. Zet de veiligheidsschakelaar UIT 3. Open de zes dekselschroeven IT <ol style="list-style-type: none"> 1. Portare il selettore ON/OFF su OFF (0) 2. Portare l'interruttore di sicurezza su OFF 3. Aprire le sei viti del copechio DE <ol style="list-style-type: none"> 1. ON/OFF-Schalter auf OFF stellen (0) 2. DC-Trennschalter auf OFF stellen 3. Sechs Gehäuseschrauben lösen
 ON  OFF <ul style="list-style-type: none"> EN Turn ON/OFF the main circuit board AC switch FR Allumer/Éteindre le commutateur AC du circuit intégré principal NL Schakel de AC-schakelaar op PCB AAN/UIT IT Chiudere/aprire (ON/OFF) il sezionatore CA principale DE Trennschalter im AC-Stromkreisverteiler EIN-oder AUS schalten 	 <ul style="list-style-type: none"> EN Inverter ON/OFF Switch: 0=OFF; 1=ON; P=Pairing/Program FR Interrupteur MARCHE/ARRÊT MARCHE = 1 ARRÊT = 0 P = Appairage NL Omvormer AAN/UIT; Schakelaar: 0=UIT; 1=AAN; P=Koppelen/Programmeren IT Selettore ON/OFF dell'inverter 0=OFF 1=ON P=Accoppiamento DE ON/OFF-Schalter des Wechselrichters: 0=OFF; 1=ON; P= Kopplung 	
 <ul style="list-style-type: none"> EN Torque value FR La valeur du couple NL Draaimomentwaarde IT Valore di coppia DE Drehmomentwert 	 <ul style="list-style-type: none"> EN Safety Switch (on optional DC Safety Unit) FR Interrupteur de sécurité (sur l'unité de sécurité DC en option) NL Veiligheidsschakelaar (op de optionele DC-veiligheidsunit) IT Interruttore di sicurezza (sull'unità di sicurezza CC opzionale) DE DC-Trennschalter (bei optionaler DC-Sicherheitseinheit) 	 <p>9.0 N*m / 6.6 ft.*lb 10.3 N*m / 7.6 ft.*lb (Plastic)</p> 
 <ul style="list-style-type: none"> EN LEDs FR LED NL Leds IT LED DE LEDs 		<ul style="list-style-type: none"> EN Close the six cover screws FR Fermer les 6 vis du couvercle NL Sluit de zes dekselschroeven IT Chiudere le sei viti del coperchio DE Sechs Gehäuseschrauben anziehen

1

- EN** INSTALLING THE POWER OPTIMIZERS
- FR** INSTALLATION DES OPTIMISEURS DE PUISSANCE
- NL** MONTAGE VAN DE POWER OPTIMIZERS
- IT** INSTALLAZIONE DEGLI OOTTIMIZZATORI DI POTENZA
- DE** INSTALLIEREN DER LEISTUNGSOPTIMIERER

1 2 3 4 5

- EN** Verify string design with Designer
- FR** Vérifier la conception des chaînes avec Designer
- NL** Controleer het ontwerp van de string met de Designer
- IT** Verificare il dimensionamento della stringa con Designer
- DE** Verifizieren Sie die Auslegung (Strang) mit dem Designer

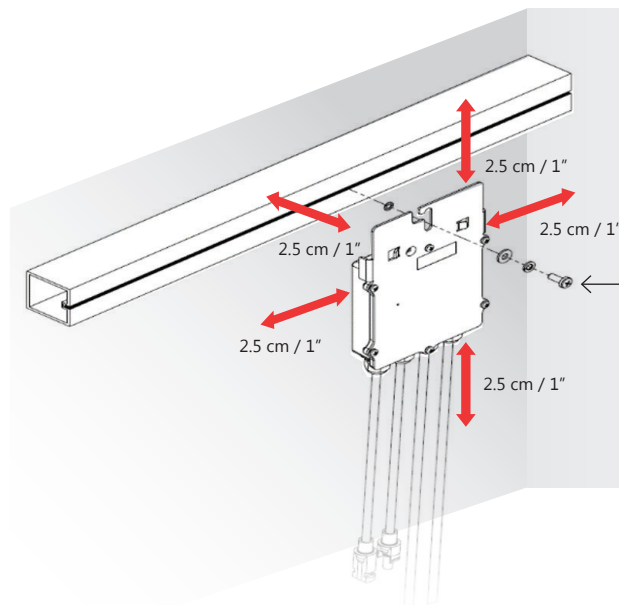
**EN**

M6 (1/4") or M8 (5/16")
stainless steel 9.5 N*m / 7 lb*ft

FR

Vis en acier inoxydable
M6 (1/4 ")/M8 (5/16") 9.5 N*m / 7 lb*ft

NL

M6 of M8 roestvrij staal 9,5 N*m

IT

Bulloni in acciaio inox di tipo M6 (1/4")
oppure M8 (5/16"), 9.5 N*m / 7 lb*ft

DE

M6 (1/4 Zoll) oder M8 (5/16 Zoll)
Edelstahlschrauben; 9.5 N*m / 7 lb*ft

1

1 2 3 4 5

EN OPTION A NL OPTIE A DE OPTION A
FR OPTION A IT OPZIONE A

EN Peel off stickers
FR Autocollants détachables
NL Verwijder de stickers
IT Staccare le etichette
DE Sticker mit QR Code abziehen

EN Scan sticker sheet
FR Scanner la feuille d'autocollants
NL Scan het stickervel
IT Scansionare il foglio con le etichette
DE Anlagenlayout (gesammelte QR-Codes) scannen

EN Email to SolarEdge support
FR Envoyer le scan à l'assistance de SolarEdge
NL Stuur de scan naar SolarEdge support
IT Invia la scansione al Servizio Assistenza SolarEdge
DE E-Mail an SolarEdge-Support senden



<http://www.solaredge.com/files/pdfs/physical-layout-template.pdf>

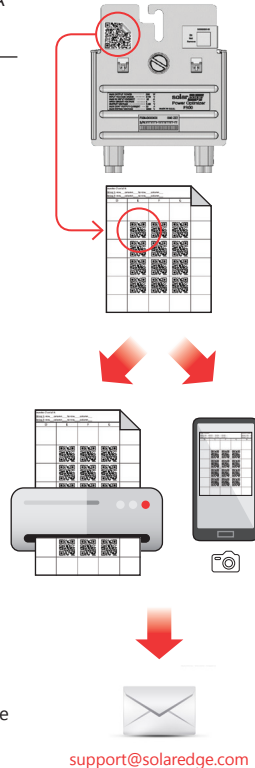

support@solaredge.com

EN OPTION B NL OPTIE B DE OPTION B
FR OPTION B IT OPZIONE B

EN Scan stickers using Mapper
FR Scanner les autocollants à l'aide du Site mapper de SolarEdge
NL Scan de stickers met gebruik van de Mapper
IT Scansionare le etichette utilizzando Mapper
DE Aufkleber mithilfe der Mapper App scannen

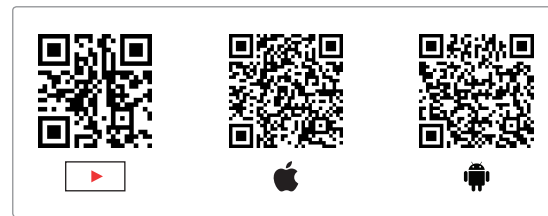

EN Complete site registration and physical layout in the monitoring platform
FR Compléter l'enregistrement du site et la disposition physique sur la plateforme de supervision
NL Volledige siteregistratie en fysieke opmaak in het monitoring platform
IT Completare la registrazione ed il layout fisico dell'impianto nella piattaforma di monitoraggio
DE Registrierung der Anlage und physikalisches Layout in der Monitoring-Plattform abschließen



1

1 2 3 4 5

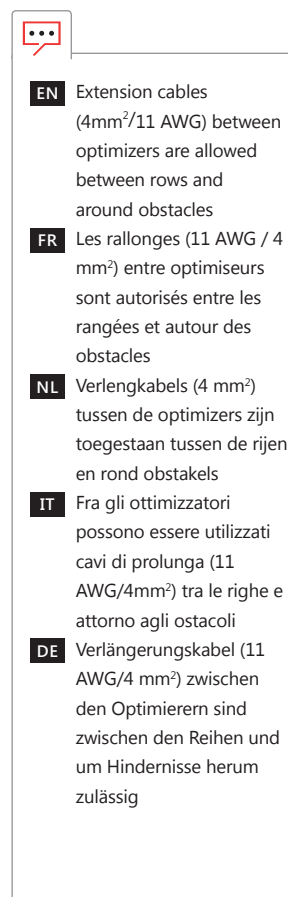
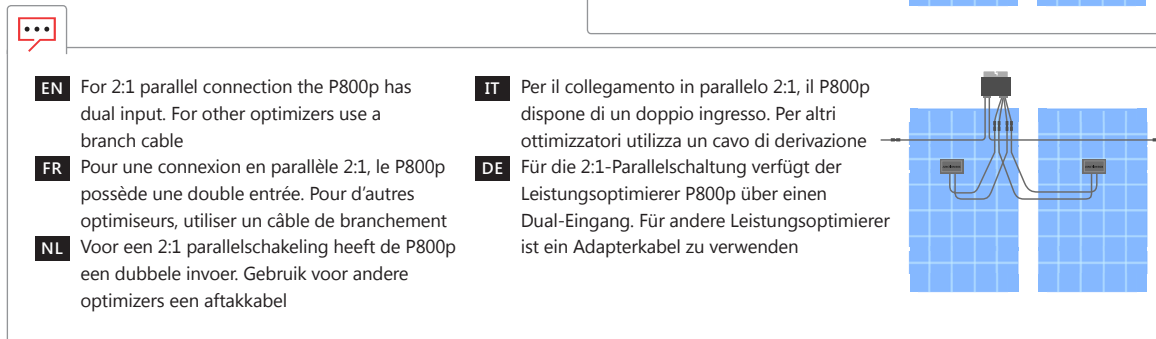
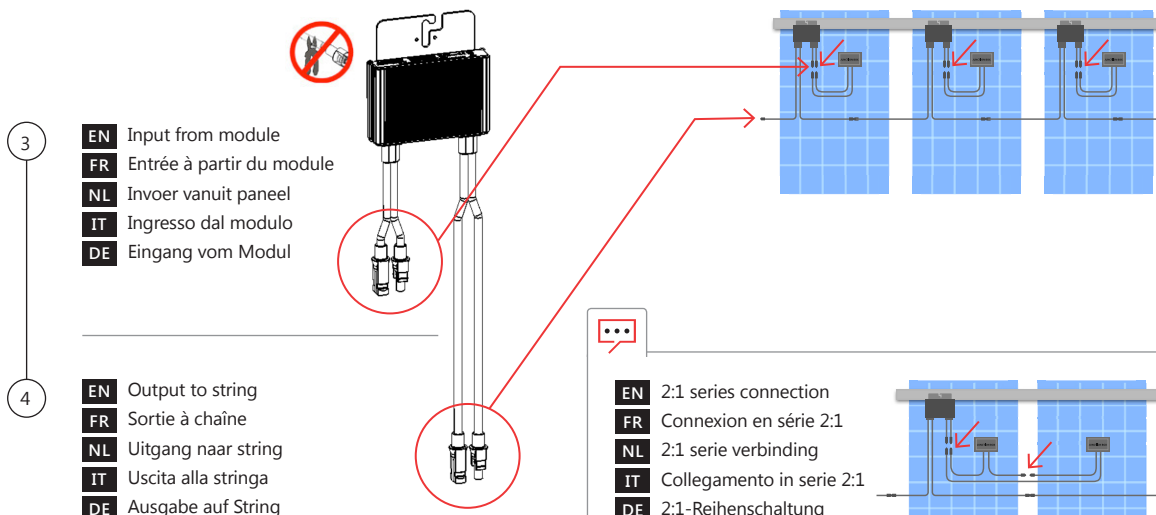

1

1 2 3 4 5

EN Check string polarity and measure each string's voltage to verify $1\pm 0.1V$ per optimizer

FR Vérifier la polarité de la chaîne et mesurer chaque tension sur chaîne pour vérifier la tension de $1\pm 0.1V$ par optimiseur

NL Controleer de polariteit van de string en meet de spanning van elke string om de $1\pm 0.1V$ per optimizer te verifiëren

IT Controllare la polarità delle stringhe e misurare la tensione di ciascuna stringa per verificare la presenza di $1\pm 0.1 V$ per ogni ottimizzatore

DE Prüfen Sie die Strang-Polarität und messen Sie die Spannung jedes Stranges, um $1\pm 0.1 V$ pro Optimierer zu bestätigen

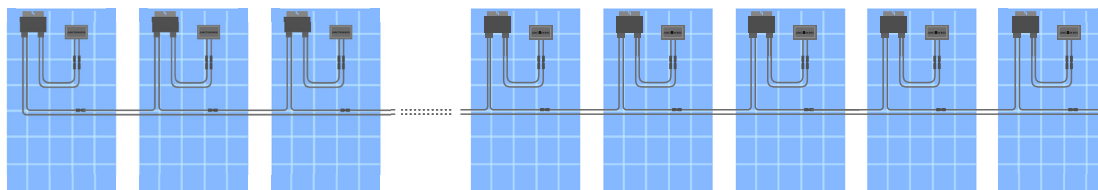

EN Example: 16 optimizers = $\sim 16V$

FR Exemple: 16 optimiseurs = $\sim 16V$

NL Voorbeeld: 16 optimizers = $\sim 16V$

IT Esempio: 16 ottimizzatori di potenza $\sim 16V$

DE Beispiel: 16 Leistungsoptimierer = $\sim 16V$

2

- EN INSTALLING THE INVERTER
 FR INSTALLATION DE L'ONDULEUR
 NL MONTAGE VAN DE OMVORMER
 IT INSTALLAZIONE DELL'INVERTER
 DE INSTALLIEREN DES WECHSELRICHTERS

1 2

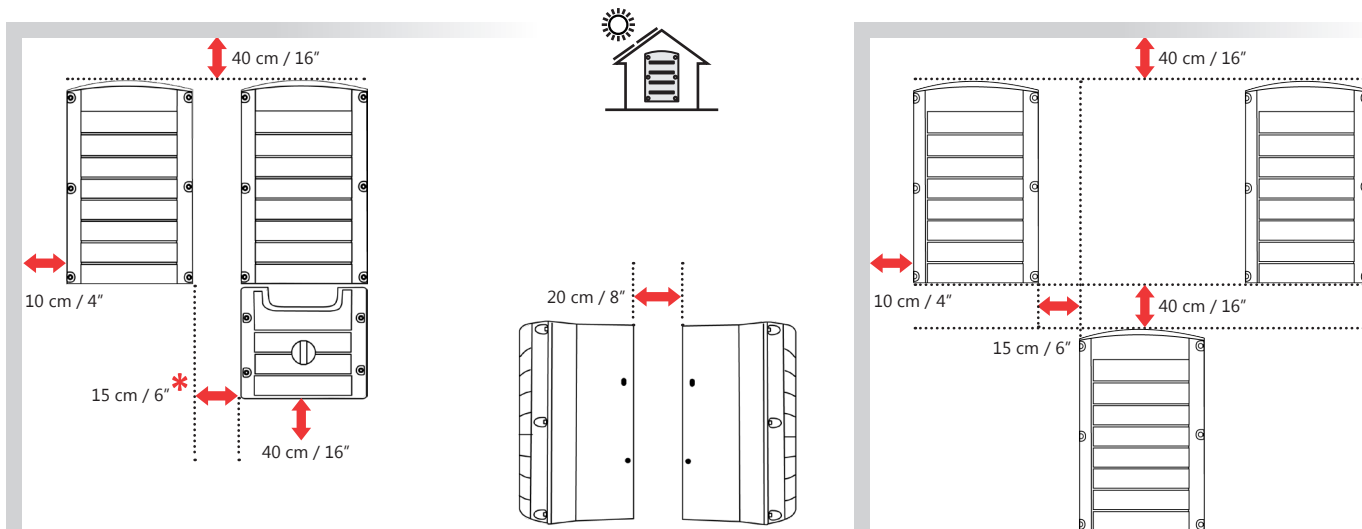

- EN * 20 cm / 8" where annual average high temperature $\leq 25^{\circ}\text{C} / 77^{\circ}\text{F}$
 FR * 20 cm / 8" lorsque la température élevée annuelle moyenne est inférieure à $25^{\circ}\text{C} / 77^{\circ}\text{F}$
 NL * 20 cm / 8" waar de jaarlijkse gemiddelde hoge temperatuur lager is dan 25°
 IT * 20 cm / 8" dove la temperatura media annuale massima è inferiore a $25^{\circ}\text{C} / 77^{\circ}\text{F}$
 DE * 20 cm / 8" Die durchschnittliche Jahreshöchsttemperatur liegt unter $25^{\circ}\text{C} / 77^{\circ}\text{F}$

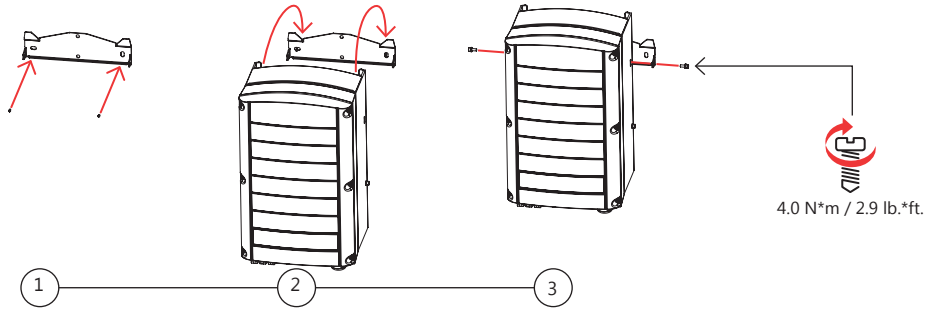
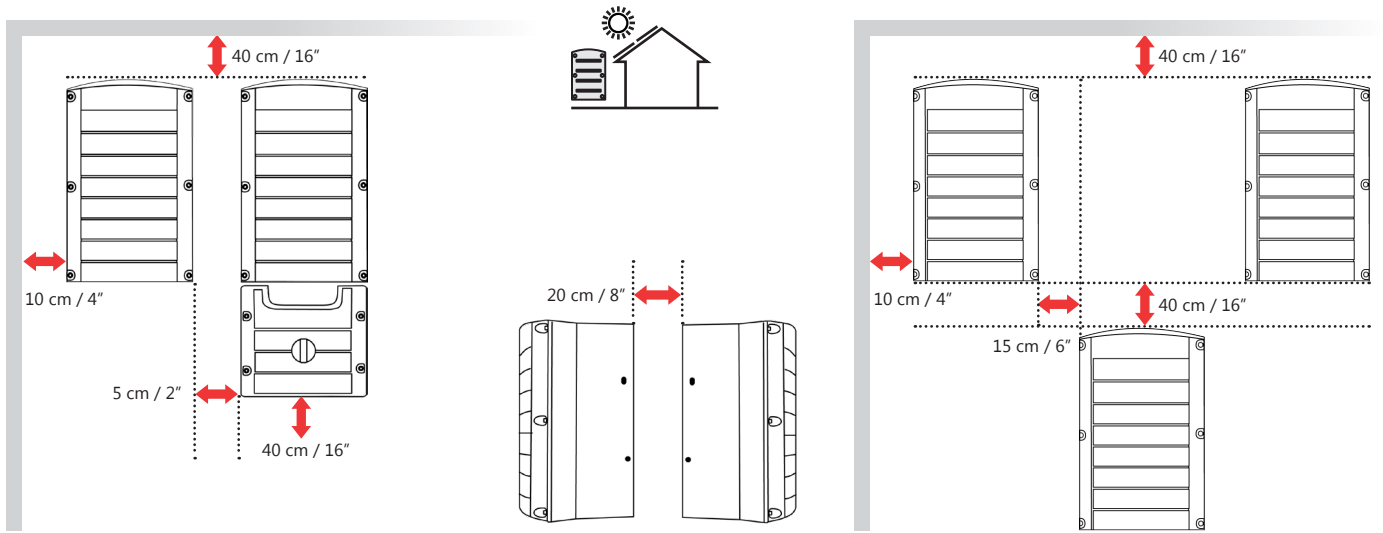

3

- EN CONNECTING THE STRINGS TO THE INVERTER
- FR CONNEXION DES CHAÎNES À L'ONDULEUR
- NL VERBINDEN VAN DE STRINGS MET DE OMVORMER
- IT COLLEGAMENTO DELLE STRINGHE ALL'INVERTER
- DE ANSCHLIEßEN DIE STRINGS UM DEN WECHSELRICHTER

1 2

1

- EN 1-3 MC4 pairs, model dependent
- FR 1-3 paires MC4, modèle dépendant
- NL 1-3 MC4-paar, afhankelijk van het
- IT 1-3 coppie MC4, in base al m
- DE 1-3 MC4 Paare, je nach Modell



- EN For additional strings in parallel use external combiner box or branch cable
- FR Pour des chaînes supplémentaires en parallèle, utilisez un coffret de raccordement ou un Y
- NL Gebruik voor parallelle strings een externe verbindingskast of een aftakingskabel
- IT Per stringhe aggiuntive in parallelo, utilizza un quadro di parallelo esterno o dei cavi di derivazione
- DE Für zusätzliche parallele Stränge verwenden Sie ein DC-GAK/Combiner Box oder Y-Kabel

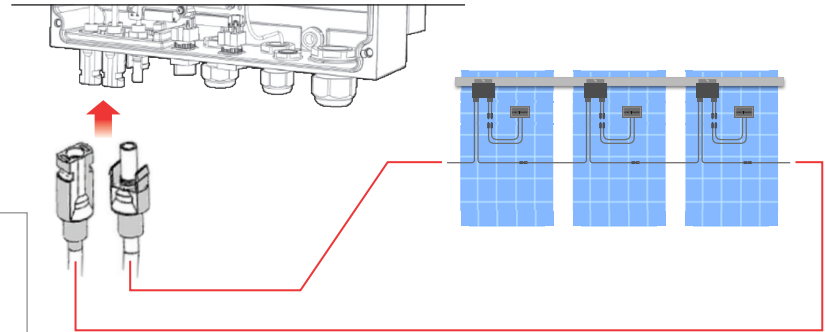

2

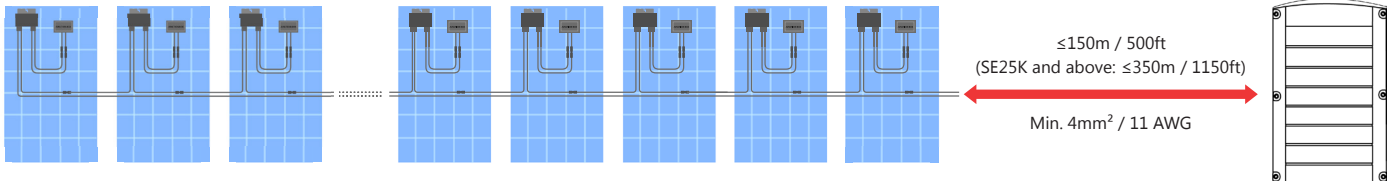

4

- EN CONNECTING THE AC TO THE INVERTER
- FR CONNEXION DU CA À L'ONDULEUR
- NL ANSLUITEN VAN AC OP DE OMVORMER
- IT COLLEGAMENTO CA DELL'INVERTER
- DE ANSCHLIEßEN DES NETZ UM DEN WECHSELRICHTER

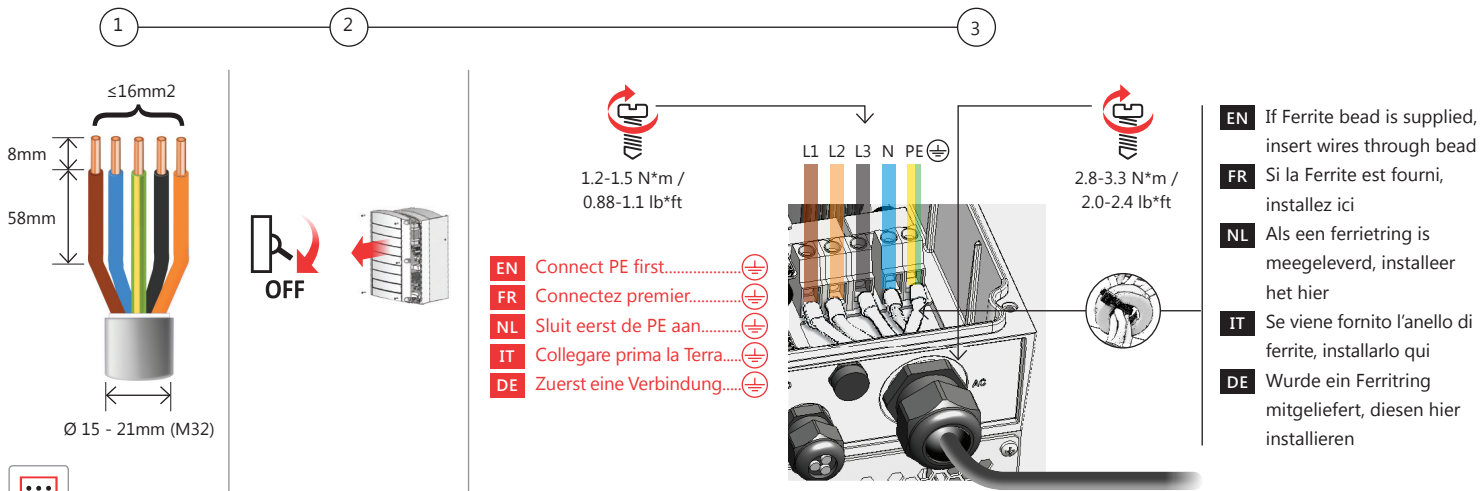

EN NOTE

Some inverters in some countries can be connected to the delta grid. Scan to read more.

FR REMARQUE

Some inverters in some countries can be connected to the delta grid. Scan to read more.

NL OPMERKING

Bepaalde omvormers kunnen aangesloten worden op een Delta netwerk (3x230V zonder nulleiding). Scan voor meer informatie.

IT NOTA

Alcuni inverter in alcuni paesi possono essere collegati a reti delta/a triangolo/ senza neutro. Scansionare per saperne di più.

DE HINWEIS

Some inverters in some countries can be connected to the delta grid. Scan to read more.



EN



FR









NL

5

- EN** SETTING UP COMMUNICATION
FR CONFIGURATION DE LA COMMUNICATION
NL COMMUNICATIE INSTELLEN
IT IMPOSTAZIONI DI COMUNICAZIONE
DE EINRICHTEN DER KOMMUNIKATION

EN Built-in: 1. Ethernet p. 12 2. RS485 p. 14	FR Intégré: 1. Ethernet p. 12 2. RS485 p. 14	NL Ingebouwd: 1. Ethernet p. 12 2. RS485 p. 14	IT Incluso: 1. Ethernet p. 12 2. RS485 p. 14	DE Integriert: 1. Ethernet p. 12 2. RS485 p. 14
--	---	---	---	--

EN Optional	FR En option	NL Optioneel	IT Opzionale	DE Optional
	EN Wi-Fi (Requires antenna) FR Wi-Fi (L'antenne est nécessaire) NL Wi-Fi (Antenne is vereist) IT Wi-Fi (È necessaria l'antenna) DE Wi-Fi (Antenne wird benötigt)			 EN
	EN ZigBee Plug-in FR Plug-in ZigBee NL ZigBee plug-in IT Scheda ZigBee DE ZigBee-Modul			 EN
	EN Cellular Plug-in FR Carte électronique cellulaire NL GSM plug-in IT Scheda cellulare DE GSM-Modul			 EN

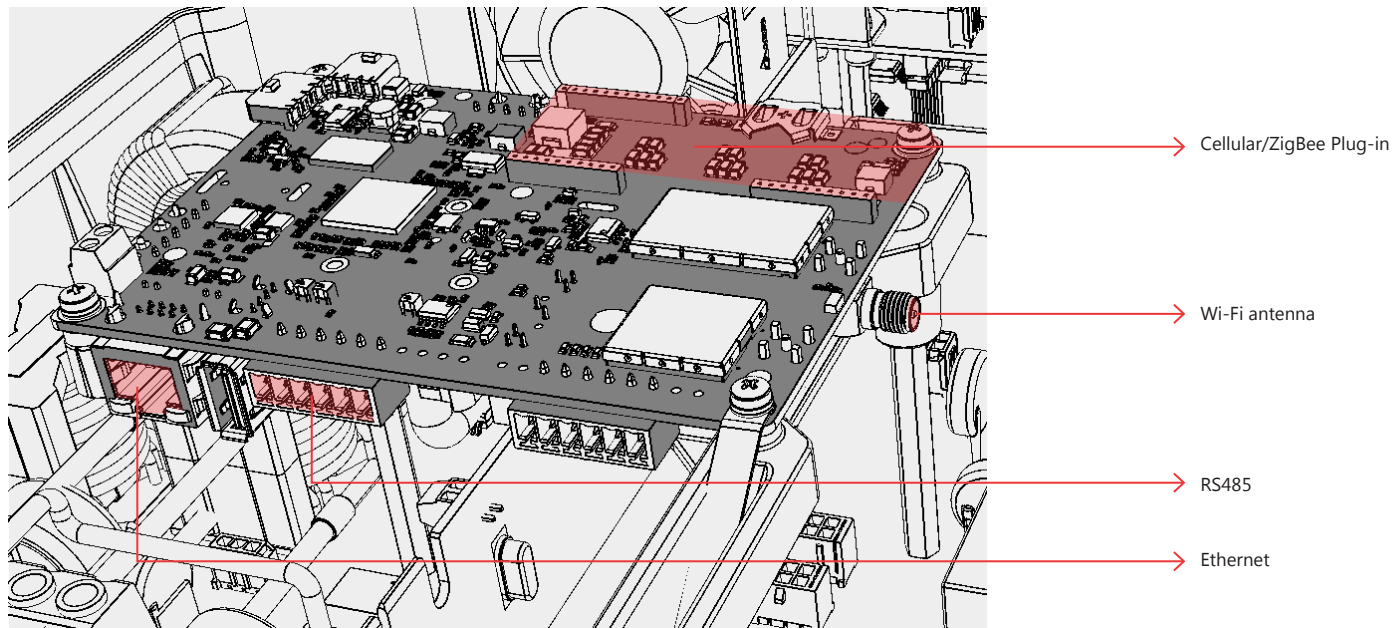

- EN** For troubleshooting
- FR** Pour le dépannage
- NL** Voor probleemoplossing
- IT** Per la risoluzione dei problemi
- DE** Zur Fehlersuche



- EN** Application note: Communication Options
- FR** Note d'application : Options de communication
- NL** Applicatie note: Communicatie opties
- IT** Per la risoluzione dei problemi
- DE** Anwendungshinweis: Kommunikationsoptionen



6

- EN CREATING AN ETHERNET (LAN) CONNECTION
 FR CRÉATION D'UN CONNEXION ETHERNET (LAN)
 NL HET MAKEN VAN EEN ETHERNET (LAN) VERBINDING
 IT CREAZIONE DI UNA CONNESSIONE ETHERNET (LAN)
 DE EINRICHTEN EINER ETHERNET-VERBINDUNG (LAN)

1 2 3 4

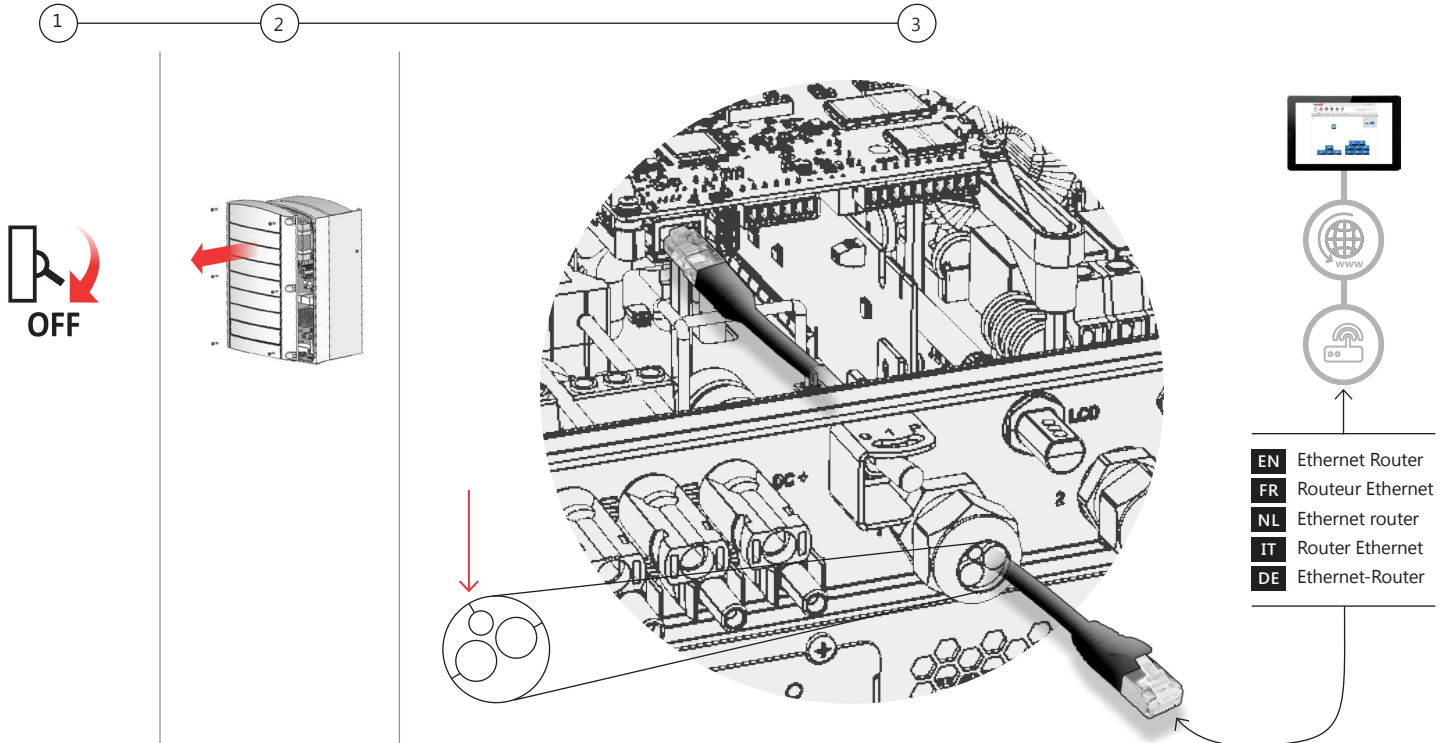

EN

RJ45 Pin #	Wire Color ¹		10Base-T Signal 100Base-TX Signal
	T568B	T568A	
1	White/Orange	White/Green	Transmit+
2	Orange	Green	Transmit-
3	White/Green	White/Orange	Transmit+
4	Blue	Blue	Reserved
5	White/Blue	White/Blue	Reserved
6	Green	Orange	Received-
7	White/Brown	White/Brown	Reserved
8	Brown	Brown	Reserved

FR

RJ45 Pin #	Couleur de câble ¹		Signal 10Base-T Signal 100Base-TX
	T568B	T568A	
1	Blanc/Orange	Blanc/Vert	Transmission+
2	Orange	Vert	Transmission-
3	Blanc/Vert	Blanc/Orange	Transmission+
4	Bleu	Bleu	Réservé
5	Blanc/Bleu	Blanc/Bleu	Réservé
6	Vert	Orange	Réceptionné-
7	Blanc/Brun	Blanc/Brun	Réservé
8	Brun	Brun	Réservé

NL

RJ45- pin- nummer	Kleur van de draden ¹		10Base-T signaal 100Base-TX signaal
	T568B	T568A	
1	Wit/Oranje	Wit/Groen	Transmit+
2	Oranje	Groen	Transmit-
3	Wit/Groen	Wit/Oranje	Transmit+
4	Blauw	Blauw	Gereserveerd
5	Wit/Blauw	Wit/Blauw	Gereserveerd
6	Groen	Oranje	Received-
7	Wit/Bruin	Wit/Bruin	Gereserveerd
8	Bruin	Bruin	Gereserveerd

IT

N. di pin del RJ45	Colore del filo ¹		Segnale 10Base-T Segnale 100Base-TX
	T568B	T568A	
1	Bianco/Arancione	Bianco/Verde	Trasmissione+
2	Arancione	Verde	Trasmissione-
3	Bianco/Verde	Bianco/Arancione	Trasmissione+
4	Blu	Blu	Riservato
5	Bianco/Blu	Bianco/Blu	Riservato
6	Verde	Arancione	Ricezione-
7	Bianco/Marrone	Bianco/Marrone	Riservato
8	Marrone	Marrone	Riservato

DE

RJ45- Kontakt- Nr.	Drahtfarbe ¹		10Base-T Signal 100Base-TX Signal
	T568B	T568A	
1	Weiß/Orange	Weiß/Grün	Senden+
2	Orange	Grün	Senden-
3	Weiß/Grün	Weiß/Orange	Empfangen+
4	Blau	Blau	Reserviert
5	Weiß/Blau	Weiß/Blau	Reserviert
6	Grün	Orange	Empfangen-
7	Weiß/Braun	Weiß/Braun	Reserviert
8	Braun	Braun	Reserviert

EN

¹ The inverter connection does not support RX/TX polarity change. Supporting crossover Ethernet cables depends on the switch capabilities

FR

¹ La connexion de polarité RX/TX. La prise en charge des câbles Ethernet croisés dépend du router/modem

NL

¹ De omvormer verbinding ondersteunt geen RX/TX polariteit veranderingen. Ondersteunen van cross-over ethernet kabels is afhankelijk van de schakelmogelijkheden

IT

¹ La connessione dell'inverter non supporta il cambio di polarità RX/TX. Il supporto di cavi Ethernet incrociati dipende dalle capacità dello switch di rete

DE

¹ Der Wechselrichteranschluss unterstützt keine RX/TX-Polaritätsänderung. Die Unterstützung von Crossover-Ethernet-Kabeln hängt davon ab ob dies von Switch/Router unterstützt wird

7

- EN** CREATING AN RS485 BUS CONNECTION
FR CRÉATION D'UNE CONNEXION BUS RS485
NL RS-485 BUS VERBINDING
IT CREAZIONE DI UNA CONNESSIONE SU BUS RS485
DE CREATING AN RS485 BUS CONNECTION

1 2

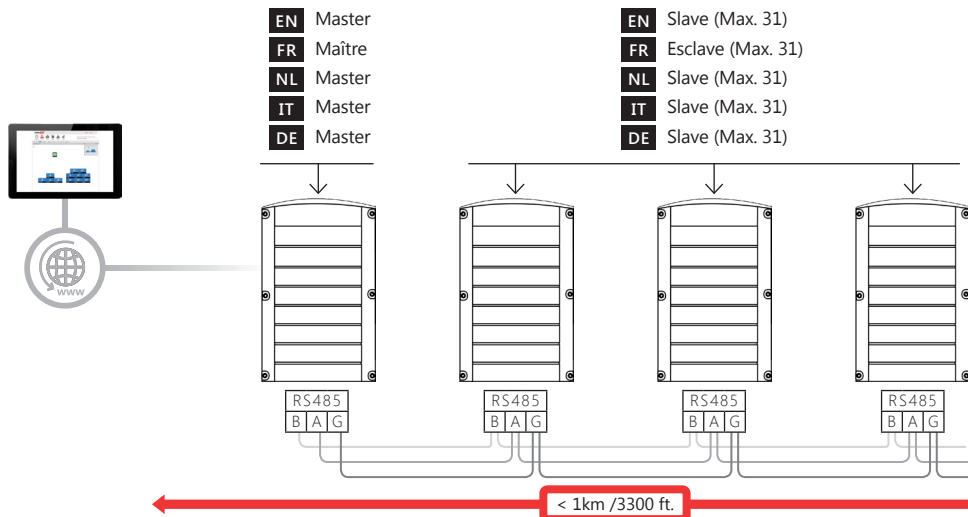

EN Min. 3-wire shielded twisted pair (a 4-wire cable may be used). Wire cross-section: 0.2-1 mm² / 24-18 AWG (a CAT5 cable may be used)

FR Min. paire torsadée blindée de 3 fils (un câble de 4 fils peut être utilisé). Section transversale du câble : 0,2-1 mm² / 24-18 AWG (un câble CAT5 peut être utilisé)

NL Minimaal 3-aderige afgeschermd twisted-pair kabel (een 4-aderige kabel kan ook worden gebruikt). Draaddoorsnede: 0,2-1 mm² (een CAT5-kabel kan worden gebruikt)

IT Doppino intrecciato schermato con 3 fili minimo (è possibile utilizzare un cavo a 4 fili) Sezione del cavo: 0,2-1 mm² / 24-18 AWG (è possibile utilizzare un cavo CAT5)

DE Min. CAT5 - 3-adrig geschirmtes Twisted Pair Kabel (es kann ein 4-adriges Kabel verwendet werden). Aderquerschnitt: 0,2-1 mm² / 24-18 AWG (es kann ein CAT5-Kabel verwendet werden)

7

1 2

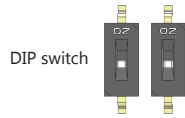

EN Terminate first and last devices: Move up SW1 DIP switch (left switch)

FR Terminaison du premier et dernier périphérique : passer le commutateur SW1 DIP (commutateur de gauche)

NL Schakel de eerste en de laatste units uit: schuif SW1 DIP-schakelaar naar boven (linker schakelaar)

IT Termina il primo e l'ultimo dispositivo: Sposta verso l'alto l'interruttore DIP SW1 (interruttore a sinistra)

DE Erstes und letztes Gerät terminieren: SW1-DIP-Schalter nach oben schieben (linker Schalter)

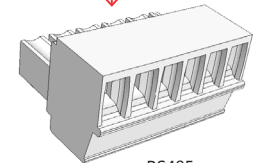
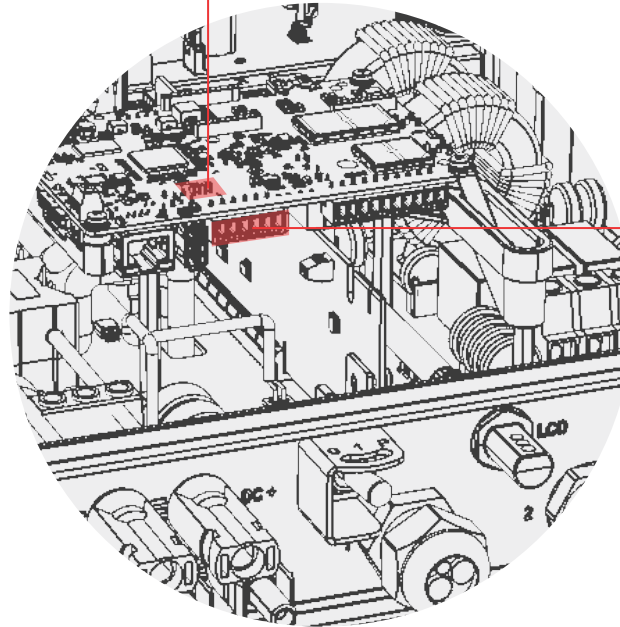

RS485



- EN** 1ST TIME SETAPP INSTALLATION
- FR** 1ERE INSTALLATION SETAPP
- NL** EERSTE SETAPP INSTALLATIE
- IT** PRIMA INSTALLAZIONE DI SETAPP
- DE** ERSTES MAL SETAPP INSTALLATION

1 — 2

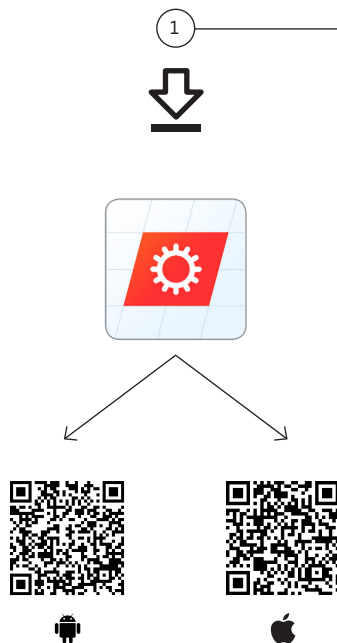
**EN** Login:

1. Open SetApp and follow the instructions
2. Log-in with your monitoring Username and password

FR Login:

1. Ouvrir SetApp et suivre les instructions.
2. S'identifier avec votre adresse E-Mails et votre mot de passe de la supervision

NL Login:

1. Open de SetApp en volg de instructies
2. Log in met je monitoring gebruikersnaam en wachtwoord

IT Login:

1. Apri SetApp e segui le istruzioni
2. Effettua l'accesso con il tuo username e password usati per il monitoraggio

DE Login:

1. SetApp öffnen und den Anweisungen folgen
2. Melden Sie sich mit Ihrem Benutzernamen und Passwort im Monitoring an

9

- EN ACTIVATING
- FR ACTIVATION
- NL ACTIVERING
- IT ATTIVAZIONE
- DE AKTIVIERUNG

1 2



1



- EN** Scan inverter QR code; for RS485 bus, scan master first
- FR** Scanner le QR code de l'onduleur; pour le bus RS485, scanner le maître en premier.
- NL** Scan de QR-code van de omvormer; scan de master-omvormer eerst i.v.m. de RS485-bus
- IT** Scansiona il QR code dell'inverter; per il bus RS485, scansiona prima il master
- DE** RS485-Bus, Scan Master zuerst

2



- EN** Follow the SetApp instructions
- FR** Suivre les instructions SetApp
- NL** Volg de SetApp instructies op het scherm
- IT** Segui le istruzioni di SetApp
- DE** Folgen Sie den SetApp Anweisungen



- EN** SetApp creates a Wi-Fi connection with the inverter
- FR** SetApp cree une connection Wifi avec l'onduleur
- NL** De SetApp creëert een wifi verbinding met de omvormer
- IT** SetApp crea una connessione Wi-Fi con l'inverter
- DE** SetApp erstellt eine Wi-Fi Verbindung mit dem Wechselrichter

10

- EN** COMMISSIONING
- FR** MISE EN SERVICE DE L'INSTALLATION
- NL** INGEBRUIKNAME
- IT** MESSA IN FUNZIONE
- DE** INBETRIEBNAHME

1 2 3 4



1

2

3

4

- EN** Set Country and Language
- FR** Selecteer land en taal
- NL** Set Country and Language
- IT** Imposta Paese e Lingua
- DE** Land und Sprache einstellen



- EN** Pair the power optimizers
- FR** Couplage des optimiseurs
- NL** Koppel de power optimizers
- IT** Esegui l'accoppiamento degli ottimizzatori
- DE** Leistungsoptimierer koppeln

- EN** Set communication to the monitoring platform and to the other inverters
- FR** Paramétrer la communication à la supervision et avec les autres onduleurs
- NL** Selecteer de communicatie methode met het monitoring platform en de andere omvormers
- IT** Imposta la comunicazione verso la piattaforma di monitoraggio e con gli altri inverter
- DE** Kommunikation zur Monitoring Plattform und zu den anderen Wechselrichtern einrichten

- EN** Set all other parameters
- FR** Paramétrer tous les autres paramètres
- NL** Stel alle andere parameters in
- IT** Imposta tutti gli altri parametri
- DE** Alle anderen Parameter einstellen

11

- EN VIEWING SYSTEM STATUS
- FR VOIR LE STATUT DU SYSTEME
- NL BEKIJK DE SYSTEEMSTATUS
- IT VISUALIZZAZIONE DELLO STATO DEL SISTEMA
- DE SYSTEMSTATUS ANZEIGEN



- EN SetApp Status screen
- FR Ecran de Statut SetApp
- NL SetApp statusscherm
- IT Schermata dello Stato su SetApp
- DE SetApp Status-Bildschirm

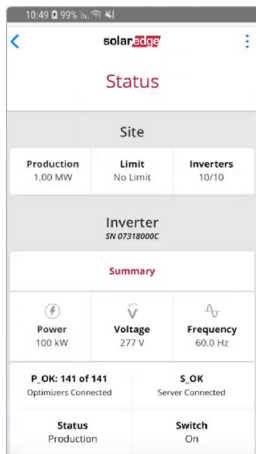

- EN Monitoring platform
- FR Plateforme de supervision
- NL Monitoring platform
- IT Piattaforma di Monitoraggio
- DE Monitoring Plattform

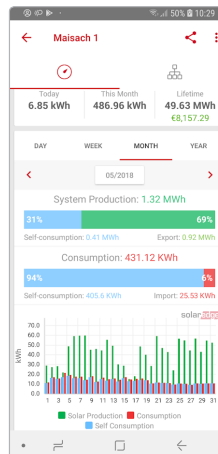



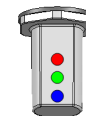





- EN Main LEDs Indications
- FR Indications LED
- NL Led indicaties
- IT indicazioni tramite i LED
- DE LED-Anzeigen



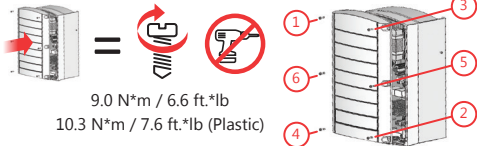

PL LEGENDA ES LEYENDA CHT LEGEND PT LEGENDA KO 범례

 <ul style="list-style-type: none"> PL Uwaga ES Nota CHT 注意 PT NOTA KO 주 	 <ul style="list-style-type: none"> PL Nie wolno przecinać złączy kabla ES No cortar los cables de los conectores CHT 不要切割續連接器的線材 PT Não cortar os conectores dos cabos KO 물의 침투를 피하기위해서, 연결부들은 결합되어야 합니다. . 케이블 연결부들을 절단하지 마십시오 	 <ul style="list-style-type: none"> PL <ol style="list-style-type: none"> 1. Wyłącz przełącznik (0) 2. Wyłącz wyłącznik bezpieczeństwa 3. Wykręć 6 śrub pokrywy ES <ol style="list-style-type: none"> 1. Mover el interruptor ON/OFF/P en OFF (0) 2. Girar el Interruptor de Seguridad en OFF 3. Quitar los seis tornillos de la tapa CHT <ol style="list-style-type: none"> 1. 將開關轉到關 (0) 位置 2. 將安全開關轉到關位置 3. 解開六個蓋板螺絲 PT <ol style="list-style-type: none"> 1. Desligar chave de segurança (posição OFF/0) 2. Desligar chave CC 3. Abrir os seis parafusos da tampa KO <ol style="list-style-type: none"> 1. ON/OFF 스위치를 OFF (0) 2. 안전 스위치 OFF 3. 6개의 커버 나사 열기
 <ul style="list-style-type: none"> PL Włącz/wyłącz główny przełącznik prądu zmiennego ES Encender o Apagar el interruptor en el cuadro de CA CHT 打開/關閉主電路板交流開關 PT Ligar/Desligar disjuntor CA do inversor KO 메인회로 보드의 AC 스위치를 ON/OFF 	 <ul style="list-style-type: none"> PL Włącznik/wyłącznik falownika: 0=WYŁ.; 1=WŁ.; P=parowanie/program ES Interruptor de ON/OFF/P del inversor: 0=Apagado; 1=Encendido; P= Emparejamiento/Programación CHT 逆變器開關: 0=關; 1=開 PT Interruptor ON/OFF do Inversor: 0=OFF; 1=ON; P=pareamento/configuração KO 인버터 ON/OFF 스위치: 0=OFF; 1=O; N P= 페어링 / 프로그램 	<ul style="list-style-type: none"> PL <ol style="list-style-type: none"> 1. Desligar chave de segurança (posição OFF/0) 2. Desligar chave CC 3. Abrir os seis parafusos da tampa KO <ol style="list-style-type: none"> 1. ON/OFF 스위치를 OFF (0) 2. 안전 스위치 OFF 3. 6개의 커버 나사 열기
 <ul style="list-style-type: none"> PL Moment obrotowy ES Par de apriete CHT 扭力值 PT Valor do Torque KO 토크 값 	 <ul style="list-style-type: none"> PL Wyłącznik bezpieczeństwa (na opcjonalnej jednostce bezpieczeństwa prądu stałego) ES Interruptor de Seguridad (en la caja de conexión CC opcional) CHT 安全開關 (在選配直流安全要求上) PT Chave CC (na Caixa CC opcional) KO 안전 스위치 (DC 안전 장치 선택사양) 	 <p>9.0 N*m / 6.6 ft.*lb 10.3 N*m / 7.6 ft.*lb (Plastic)</p> <ul style="list-style-type: none"> PL Close the six cover screws ES Fermer les 6 vis du couvercle CHT 鎖緊六個蓋板螺絲 PT Aperte os Seis Parafusos da Tampa KO 너지 (6本) を締める
 <ul style="list-style-type: none"> PL LEDy ES LEDs CHT LED指示燈 PT LEDs KO 모든 LED가 ON LED 		

1

- PL** INSTALOWANIE OPTYZMALIZATORÓW MOCY
- ES** INSTALACIÓN DE LOS OPTIMIZADORES DE POTENCIA
- CHT** 安裝功率優化器
- PT** INSTALANDO OS OTIMIZADORES DE POTÊNCIA
- KO** 파워 옵티마이저 설치

1 2 3 4 5

- PL** Sprawdź projekt łańcucha za pomocą programu Designer
- ES** Verifique el diseño con "Designer"
- CHT** 透過Designer 確認串列設計
- PT** Verificar o design da string com o Designer
- KO** 디자이너 프로그램으로 스트링 설계결과를 확인 바랍니다.

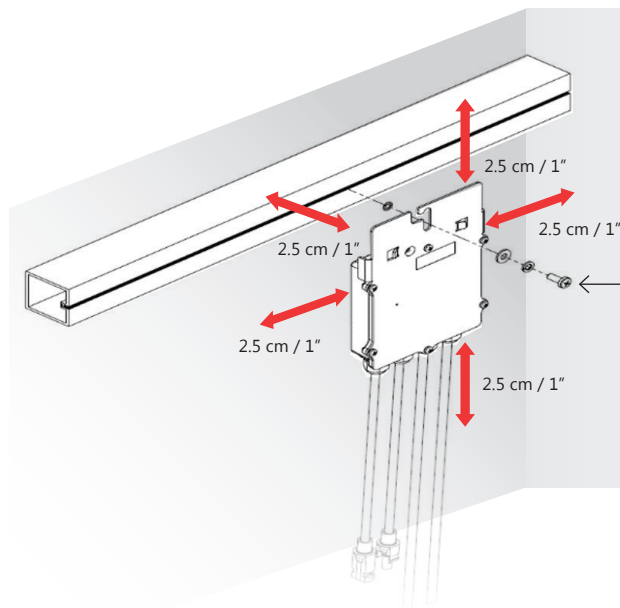

- PL**
M6 (1/4") lub M8 (5/16") stal nierdzewna
9,5 N*m / 7 funty*stopy
- ES**
Tornillos M6 (1/4") o M8 (5/16") de acero
inoxidable: 9,5 N*m / 7 libras*pie
- CHT**
M6 (1/4英寸) 或 M8 (5/16英寸) 不銹鋼 9.5
牛頓·米 / 7 磅·英尺
- PT**
M6 (1/4") ou M8 (5/16")
aço inoxidável 9.5 N*m / 7 lb*ft
- KO**
M6 (1/4') 또는 M8 (5/16")
스테인리스 스틸 9.5 N*m / 7 lb*ft

1

1 2 3 4 5

PL OPCJA A CHT 選項 A KO 옵션 A
 ES OPCIÓN A PT OPÇÃO A

PL Odklej naklejki
 ES Despegar las etiquetas
 CHT 撕下標貼
 PT Remova os QR-Codes
 KO 스티커 제거 하세요

PL Zeskanuj arkusz naklejek
 ES Escanear la hoja con las etiquetas
 CHT 掃描標貼單
 PT Escanear a folha com QR-Codes
 TH 스티커 시트 스캔 하세요

PL Wyślij mail do wsparcia SolarEdge
 ES Enviar a la asistencia técnica de SolarEdge
 CHT EMAIL至SOLAREEDGE支援部門
 PT Enviar folha com QR-Codes ao suporte técnico SolarEdge
 TH 스캔한 자료를 SolarEdge 지원센터에 보내주세요



<http://www.solaredge.com/files/pdfs/physical-layout-template.pdf>

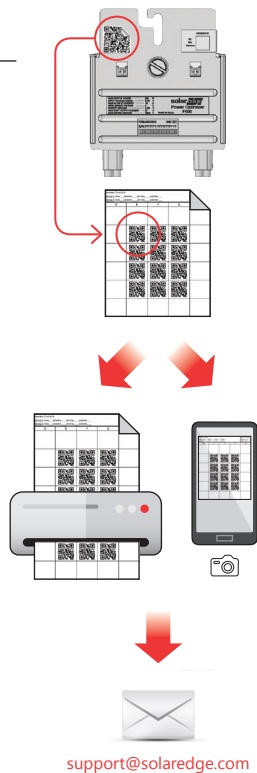

support@solaredge.com

PL OPCJA B CHT 選項 B KO 옵션 B
 ES OPCIÓN B PT OPÇÃO B

PL Zeskanuj naklejki za pomocą aplikacji Mapper
 ES Escanear las etiquetas utilizando el Site Mapper
 CHT 使用SITE MAPPER掃描標貼
 PT Escanear QR-Codes com app Site Mapper
 KO SolarEdge 사이트 매퍼를 이용하여 스티커 스캔을 하세요

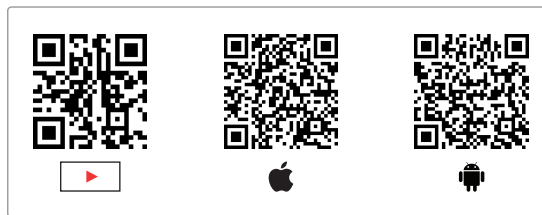

PL Wykonaj procedurę rejestracji obiektu i fizycznego rozmieszczenia na platformie monitorowania
 ES Completar el registro de la planta y el layout físico en el portal de monitorización
 CHT 在監控平臺上完成電站註冊和物理佈局圖
 PT Complete o registro do sistema e o layout físico na plataforma de monitoramento
 KO 모니터링 플랫폼에 모듈 배치와 사이트 등록을 하시기 바랍니다. 스캔을 하세요



1

1 2 3 4 5

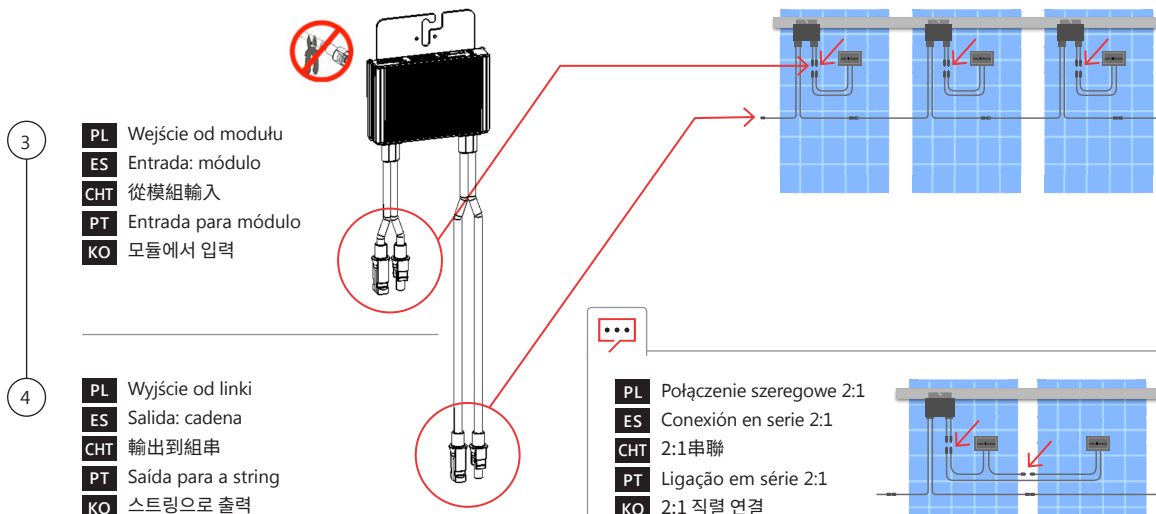

- PL** Kable przedłużające (11 AWG / 4 mm²) pomiędzy optymalizatorami są dozwolone między rzędami i wokół przeszkód
- ES** Cables de extensión (11AWG/4mm²) entre optimizadores son permitidos para conexión entre fila o rodear algún obstaculo
- CHT** 功率優化器之間可使用直流延長電纜(11 AWG/4MM²)
- PT** Cabos de emenda (4mm²) entre otimiza dores são permitidos entre fileiras e obstáculos
- KO** 옵티마이저간 추가 케이블 (11 AWG / 4 mm²)은 가로열과 장애물 간 사용이 허용됩니다

PL W przypadku połączenia równoległego P800p mają podwójne wejście. W przypadku innych optymalizatorów należy użyć przewodu rozgałęziającego

ES Para la conexión en paralelo 2:1 el P800p tienen doble entrada. Para otros optimizadores, utilizar un adaptador

CHT 對於2:1並聯, P800p擁有雙輸入口。對於其他優化器, 使用分支電纜

PT Para ligação paralela 2:1, o P800p têm entrada dupla. Para outros otimizados, usar cabo/conector "Y"

KO 2:1 병렬 연결을 위해서, P800p는 두개의 입력을 가집니다. 다른 옵티마이저를 위해서는 분기 케이블을 사용합니다.

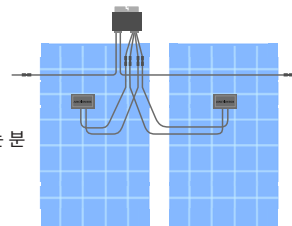

1

1 2 3 4 5

PL Sprawdź biegunowość łańcucha i zmierz napięcie każdego z nich, aby upewnić się, że wynosi $1\pm 0,1V$ na optymalizator

ES Comprobar la polaridad de la cadena y medir el voltaje de cada cadena para verificar que tenga $1\pm 0,1V$ por optimizador

CHT 檢查組串極性，測量每個組串的電壓，以確認每個優化器為1伏

PT Verificar polaridade e medir tensão de cada string; confirmar $1V$ por otimizador

KO 스트링 극성을 확인하고 옵티마이저당 1V를 입증하기 위해서 각 스트링의 전압을 측정하세요

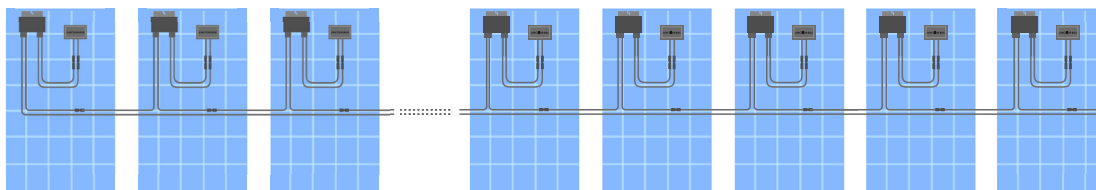

PL Przykład: 16 optymalizatorów = $\sim 16 V$

ES Ejemplo: 16 optimizadores = $\sim 16V$

CHT 例如：16個優化器 = ~ 16 伏

PT Exemplo: 16 optimizadores = $\sim 16V$

KO 예: 16 개 옵티마이저 = $\sim 16V$

2

PL INSTALOWANIE FALOWNIKA

ES INSTALAR EL INVERSOR

CHT 安裝逆變器

PT INSTALANDO O INVERSOR

KO 인버터 설치

1

2

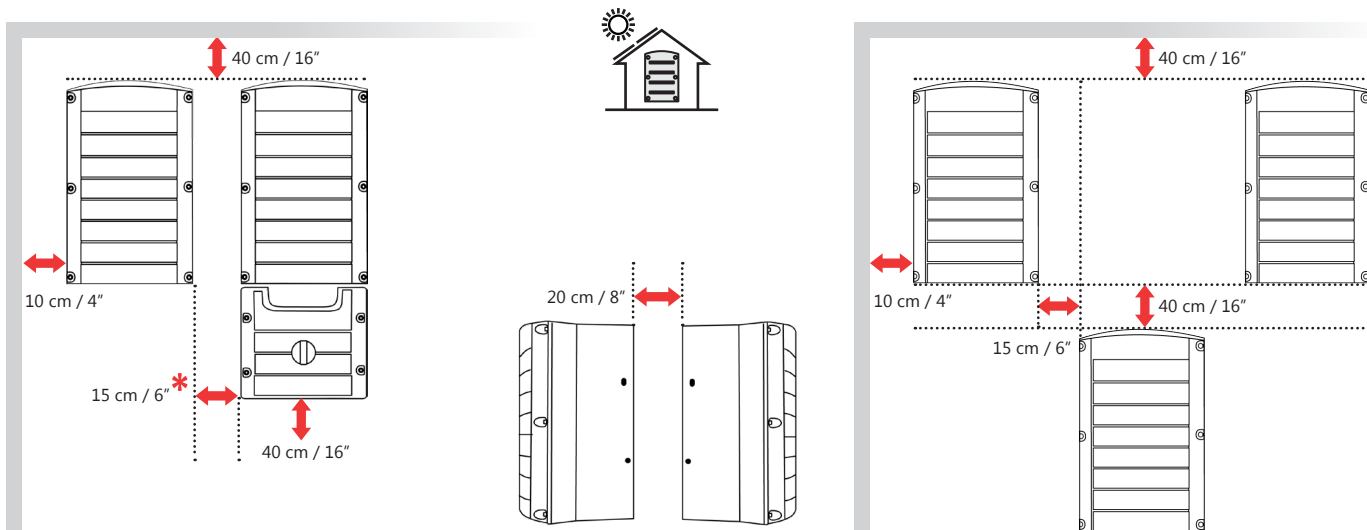

PL * 20 cm / 8" där den årliga genomsnittliga högsta temperaturen är under 25°C / 77°F

ES * 20 cm / 8" cuando el promedio anual de temperatura máxima es menor de 25°C / 77°F

CHT * 逆變器之間20釐米/8英寸 年平均高溫低於25°C / 77°F

PT * 20 cm / 8" onde a média anual de alta temperatura é abaixo de 25°C/77°F

KO * 인버터 사이의 간격 20 cm / 8 연간 평균 고온이 25°C / 77°F 이하인 곳

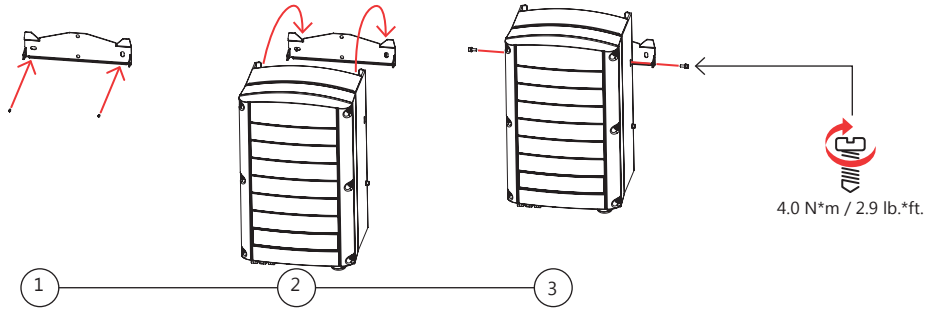
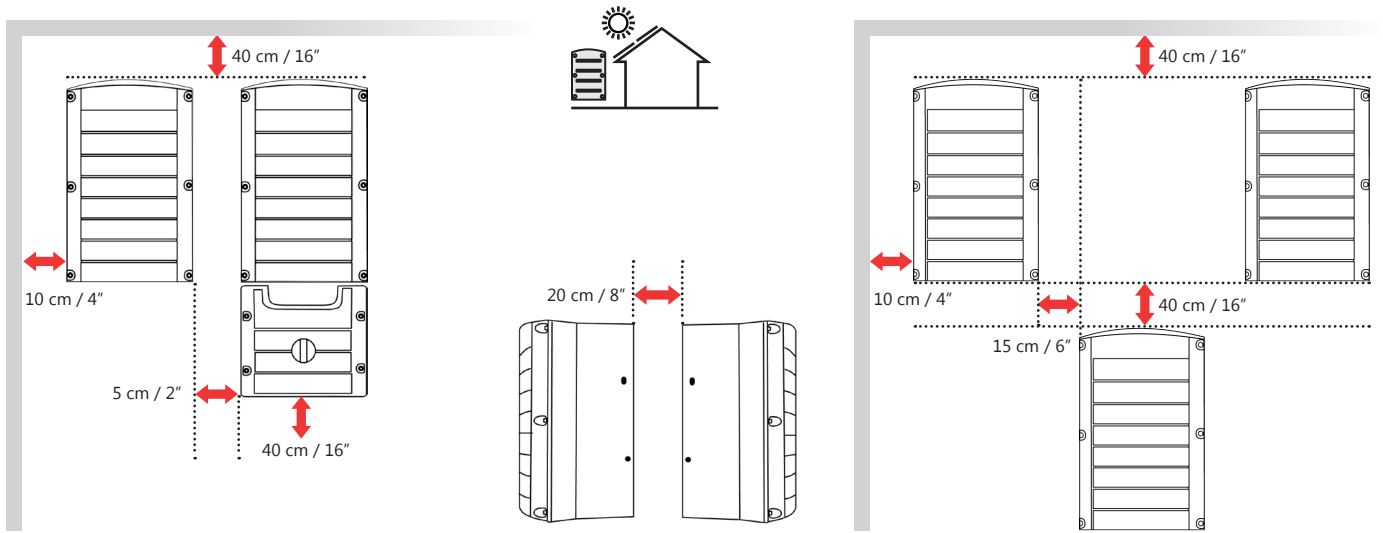

3

- PL** PODŁĄCZANIE LINEK DO FALOWNIKA
- ES** CONECTAR LAS CADENAS AL INVERSOR
- CHT** 將組串連接到逆變器
- PT** CONECTAR OS FIOS AO INVERSOR
- KO** 스트링을 인버터에 연결

1 2

1

- PL** 1-3 pary MC4, w zależności od modelu
- ES** 1-3 pares de MC4, dependiendo del modelo
- CHT** 1-3對MC4接口·取決於型號
- PT** 1-3 pares MC4, dependendo do modelo
- KO** 1-3 MC4 쌍, 모델에 따라 다름



- PL** Aby uzyskać dodatkowe łańcuchy równoległe, należy użyć zewnętrznej skrzynki rozgałęźnej lub rozgałęźnika
- ES** Para más cadenas en paralelo utilizar una caja de conexión o un adaptador externo
- CHT** 請使用分支電纜或直流匯流箱連接額外的直流組串
- PT** Para ligar mais strings em paralelo, use string-box externa ou "cabo Y"
- KO** 병렬로 구성된 추가 스트링에 별도의 접속반 및 분기 케이블 사용

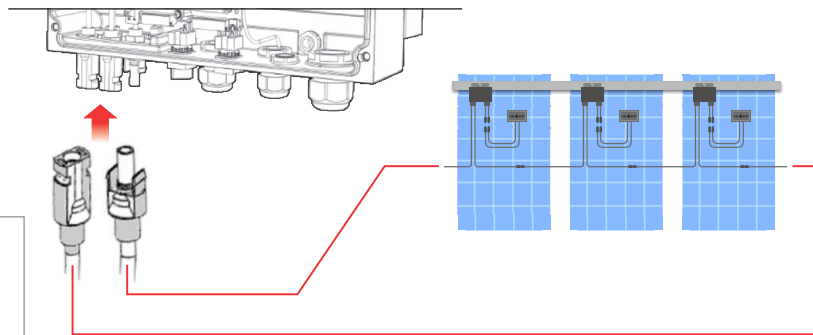

2

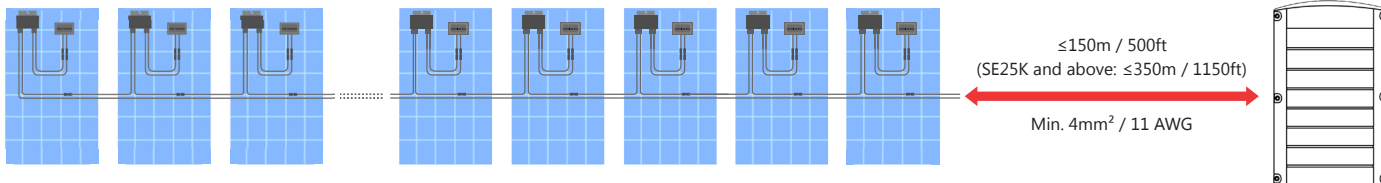

4

- PL** PODŁĄCZANIE ZASILANIA DO FALOWNIKA
ES CONECTAR LA CA AL INVERSOR
CHT 將交流電源連接到逆變器
PT CONECTAR O AC AO INVERSOR
KO AC를 인버터에 연결

1 2 3

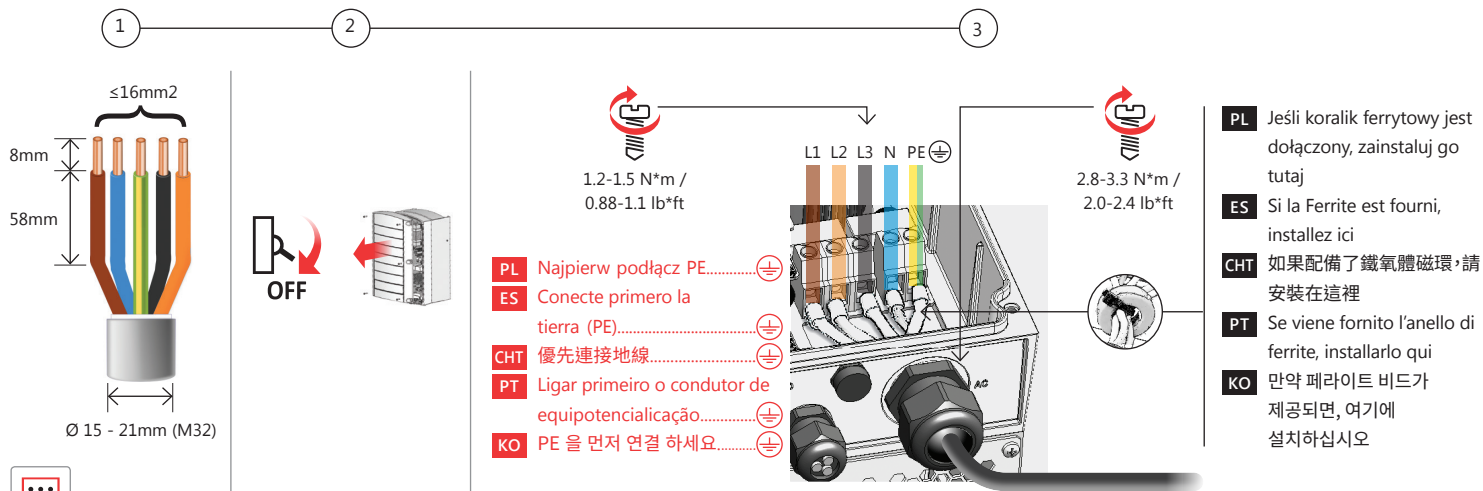
**PL UWAGA**

Niektóre falowniki w pewnych krajach można podłączać do sieci delta. Zeskanuj, aby dowiedzieć się więcej.

ES NOTA

Algunos inversores en algunos países pueden conectarse a la red delta. Escanee para leer más.

CHT 注意

部分國家的部分逆變器可以連接到三角形接法電網。掃描閱讀更多。

PT NOTA

Alguns inversores, em alguns países, podem ser conectados à rede delta. Digitalize para saber mais.

KO 주

일부 국가의 일부 인버터는 델타 그리드에 연결할 수 있습니다. 자세한 내용을 위해 스캔하십시오.



EN



FR









NL

5

- PL** KONFIGUROWANIE KOMUNIKACJI
ES CONFIGURAR LA COMUNICACIÓN
CHT 通訊設定
PT CONFIGURANDO A COMUNICAÇÃO
KO 통신 설정

PL Wbudowane: 1. Ethernet p. 32 2. RS485 p. 34	ES Incorporado: 1. Ethernet p. 32 2. RS485 p. 34	CHT 內建: 1. 乙太網路 p. 32 2. RS485 p. 34	PT Embutido: 1. Ethernet p. 32 2. RS485 p. 34	KO 빌트인: 1. 이더넷 p. 32 2. RS485 p. 34
---	---	---	--	--

PL Opcjonalne	ES Opcional	CHT 選配	PT Opcional	KO
	PL Wi-Fi (Wymagana jest antena) ES Wi-Fi (La antena es requerida) CHT Wi-Fi (需要天線) PT Wi-Fi (Antena é necessária) KO Wi-Fi (안테나 설치가 필요합니다.)			 EN
	PL Wtyczka ZigBee ES Plug-in ZigBee CHT 插入式Zigbee PT Tomada Zigbee KO Zigbee 플러그인			 EN
	PL Wtyczka komórkowa ES Módulo celular CHT 無線插入式模組 PT Plug-in GSM KO 셀룰러 플러그인			 EN

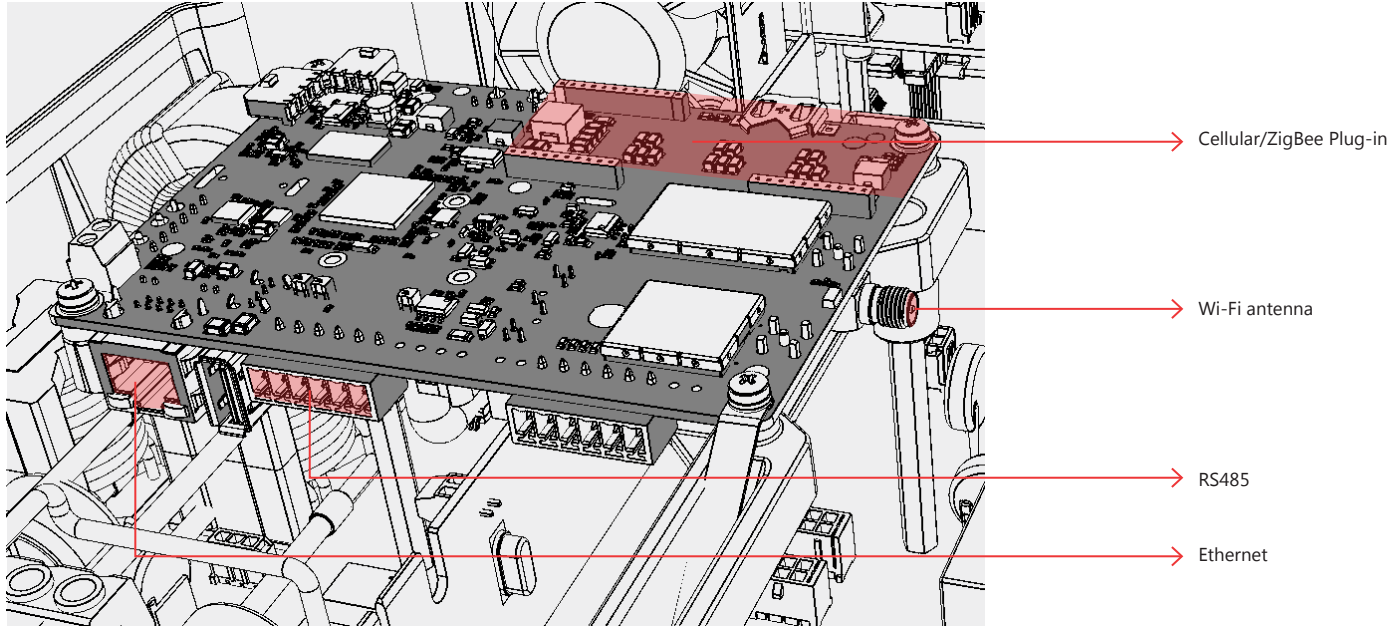

PI Rozwiązywanie problemów
ES Para resolución de problemas
CHT 故障排除
PT Para resolução de problemas
KO 문제해결용



PI Informacje o zastosowaniu: opcje komunikacji
ES Nota de aplicación: Opciones de comunicación
CHT 應用備註: 通訊選項
PT Nota de Aplicação: Opções de Comunicação
KO 적용 메모: 통신 옵션



6

- PL USTANAWIANIE POŁĄCZENIA ETHERNET (LAN)
 ES CREAR UNA CONEXIÓN ETHERNET (LAN)
 CHT 創建乙太網路 (LAN) 連接
 PT CRIANDO UMA CONEXÃO ETHERNET (LAN)
 KO 이더넷 (LAN) 연결 만들기

1 2 3 4

1

2

3

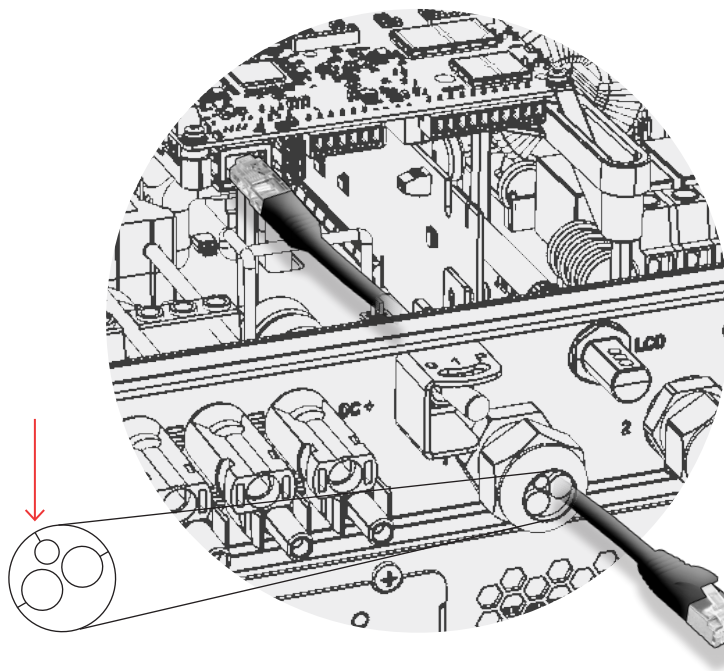
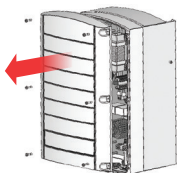

- PI Router ethernetowy
 ES Router Ethernet
 CHT 以太網路路由器
 PT Router Ethernet
 KO 이더넷 라우터

PL

Styk RJ 45	Kolor przewodu ¹		Sygnał 10Base-TX Sygnał 100Base-TX
	T568B	T568A	
1	Biały/pomarańczowy	Biały/zielony	Transmit+
2	pomarańczowy	zielony	Transmit-
3	Biały/zielony	Biały/pomarańczowy	Receive+
4	Niebieski	Niebieski	Reserved
5	Biały/niebieski	Biały/niebieski	Reserved
6	zielony	pomarańczowy	Received-
7	Biały/brązowy	Biały/brązowy	Reserved
8	brązowy	brązowy	Reserved

CHT

RJ45引 腳#	電線顏色 ¹		T568B T568A 100Base-發送信號
	T568B	T568A	
1	白色/橙色	白色/綠色	發送+
2	橙色	綠色	發送-
3	白色/綠色	白色/橙色	接收+
4	藍色	藍色	保留
5	白色/藍色	白色/藍色	保留
6	綠色	橙色	接收-
7	白色/棕色	白色/棕色	保留
8	棕色	棕色	保留

KO

RJ45 핀 #	와이어 색상 ¹		10Base-TX 신호 100Base-TX 신호
	T568B	T568A	
1	흰색/오렌지	흰색/녹색	전송+
2	오렌지	녹색	전송-
3	흰색/녹색	흰색/오렌지	수신+
4	블루	블루	예약
5	흰색/블루	흰색/블루	예약
6	녹색	오렌지	수신-
7	흰색/브라운	흰색/브라운	예약
8	브라운	브라운	예약

ES

RJ45 Pin #	Color del cable ¹		T568B T568A Señal 100Base-TX
	T568B	T568A	
1	Blanco/Naranja	Blanco/Verde	Transmitir+
2	Naranja	Verde	Transmitir-
3	Blanco/Verde	Blanco/Naranja	Recibir+
4	Azul	Azul	Reservado
5	Blanco/Azul	Blanco/Azul	Reservado
6	Verde	Naranja	Recibir-
7	Blanco/Marrón	Blanco/Marrón	Reservado
8	Marrón	Marrón	Reservado

PT

Pino RJ45 #	Cor do fio ¹		Sinal 10Base-TX Sinal 100Base-TX
	T568B	T568A	
1	Branco/Laranja	Branco/Verde	Transmissor+
2	Laranja	Verde	Transmissor-
3	Branco/Verde	Branco/Laranja	Receptor+
4	Azul	Azul	Reservado
5	Branco/Azul	Branco/Azul	Reservado
6	Verde	Laranja	Receptor-
7	Branco/Marrom	Branco/Marrom	Reservado
8	Marrom	Marrom	Reservado

PL ¹Połączenie falownika nie obsługuje zmiany biegunowości RX/TX. Obsługa krosowych kabli ethernetowych zależy od możliwości przełączania

ES ¹La conexión del inversor no es compatible con cambio de polaridad de RX/TX. La compatibilidad con cables Ethernet cruzados depende de las capacidades del switch

CHT ¹逆變器連接不支援接收/發送極性更改。是否支援交叉乙太網路電纜取決於集線器能力

PT ¹A conexão do inversor não suporta inversão de polaridade RX/TX. O suporte a cabos 'crossover' depende do switch

KO ¹인버터 연결이 RX/TX 극성 변경을 지원하지 않습니다. 이 더넷 케이블 전체의 지원은 스위치 성능에 달려 있습니다

7

- PL** USTANAWIANIE POŁĄCZENIA Z MAGISTRALĄ RS485
- ES** CREAR UNA CONEXIÓN DE BUS RS485
- CHT** 建立RS485匯流排連接
- PT** CRIANDO UMA CONEXÃO COM BARRAMENTO RS485
- KO** RS485 버스 연결 만들기

1 2

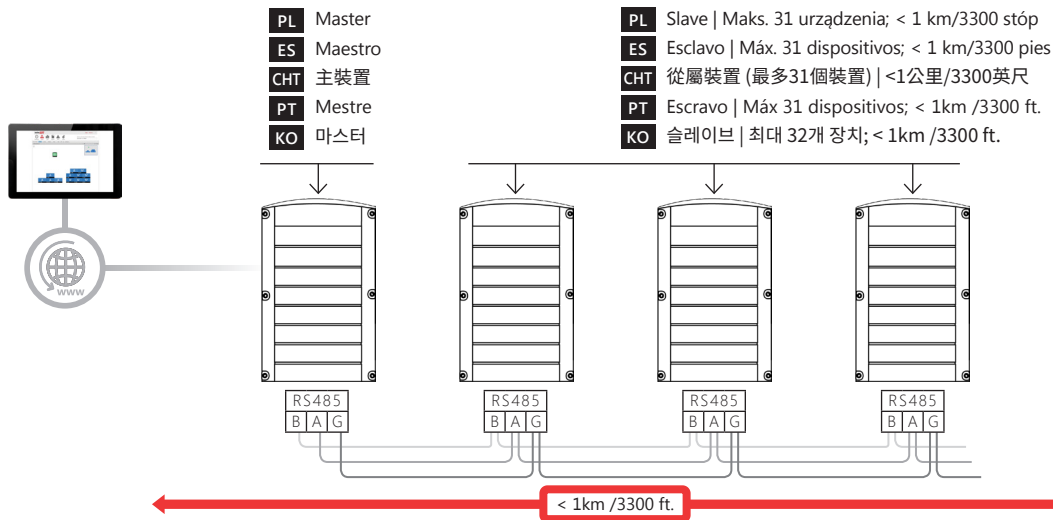
**PL**

Min. 3-żyłowa skrętka ekranowana (można użyć kabla 4-żyłowego)
Średnica przewodu: 0,2-1 mm² / 24-18 AWG (można użyć kabla CAT5)

ES

Mín. cable apantallado de 3 pares de cables trenzados (se puede usar un cable de 4 pares de cables trenzados) Sección transversal del cable: 0,2-1 mm² / 24 -18 AWG (se puede usar un cable CAT5)

CHT

最低3線遮罩雙絞線(可使用4線電纜) 電線橫截面:0.2-1平方毫
米/24-18美國線規(可使用CAT5電纜)

PT

Mín. de 3 fios, par trançado blindado (pode ser usado cabo de 4 fios). Seção transversal do fio: 0,2-1 mm² / 24-18 AWG (pode ser usado um cabo CAT5)

KO

최소 3 차폐 연선 (4 연선을 사용할 수도 있음)
와이어 단면: 0.2-1 mm² / 24-18 AWG (CAT5 케이블을 사용할 수도 있음)

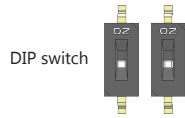

DIP switch

- PL** Rozłączyć pierwsze i ostatnie urządzenie: Przesunąć w górę przełącznik SW1 DIP (lewy przełącznik)
- ES** Terminar el bus en el primero y último dispositivos: Mover el interruptor DIP SW1 hacia arriba (interruptor izquierdo)
- CHT** 終止第一個和最後一個裝置：上移SW1 DIP開關（左開關）
- PT** Ligar o terminador do primeiro e do último dispositivo: Mova o DIP switch SW1 (switch esquerdo)
- KO** 첫 번째와 마지막 인버터 연결종결 : SW1 DIP 스위치 위로 이동 (왼쪽 스위치)

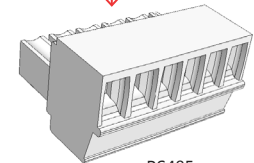
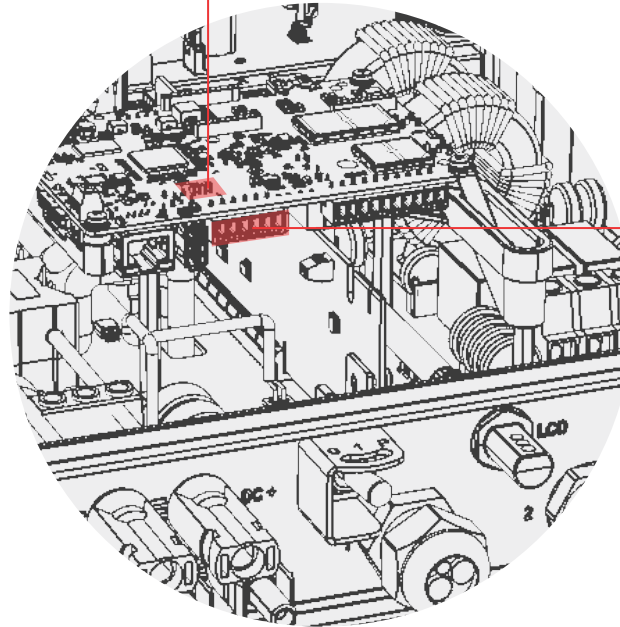

RS485

8

- PL** PIERWSZA INSTALACJA SETAPP
- ES** PRIMERA INSTALACIÓN SETAPP
- CHT** 首次使用SETAPP安裝
- PT** 1.ª INSTALAÇÃO COM SETAPP
- KO** 최초 SETAPP 설치

1 — 2

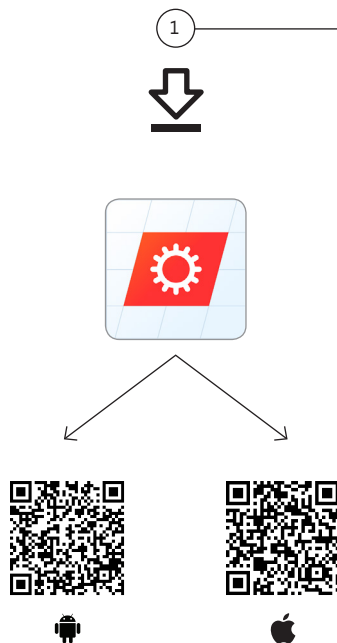
**PL** Login:

1. Otwórz SetApp i postępuj zgodnie z instrukcjami
2. Zaloguj się przy pomocy swojej nazwy użytkownika i hasła do monitorowania

ES Login:

1. Abrir SetApp y seguir las instrucciones
2. Acceder con el usuario y contraseña del monitoring

CHT 登入:

1. 打開SetApp並按照說明步驟操作
2. 使用您的監控平台帳號及密碼登入

PT Login:

1. Abrir SetApp e seguir instruções
2. Logar com seu usuário e senha do Monitoramento

KO 로그인:

1. SetApp을 실행하여 지침을 따름
2. User name 과 Password 를 이용하여 모니터링 로그인

9

- PL AKTYWACJA
- ES ACTIVANDO
- CHT 激活
- PT ATIVAÇÃO
- KO 활성화

1 — 2



- PL** Zeskanuj kod QR falownika; dla magistrali RS485, najpierw wyszukaj master
- ES** Escanear el código QR del inversor; en caso de bus RS485, escanear primero el Maestro
- CHT** 掃描逆變器QR Code; 如果有其他RS485之系統, 請先掃描主逆變器
- PT** RS-485, escanear primeiro o mestre.
- KO** 인버터 QR 코드 스캔 ; RS485 연결을 위해 마스터 인버터 우선 스캔

- PL** Postępuj zgodnie z instrukcjami SetApp
- ES** Seguir las instrucciones de la SetApp
- CHT** 按照SetApp說明步驟操作
- PT** Seguir instruções do SetApp
- KO** SetApp 지침을 따름

- PL** SetApp tworzy połączenie Wi-Fi z falownikiem
- ES** SetApp establece una conexión Wi-Fi con el inversor
- CHT** SetApp與逆變器通過Wi-Fi連接
- PT** SetApp cria uma conexão wi-fi com o inversor
- KO** SetApp 은 인버터간 와이파이 연결로 생성



10

- EN URUCHOMIENIE INSTALACJI
 FR PUESTA EN MARCHA
 CHT 調試安裝
 PT PÔR A INSTALAÇÃO EM FUNCIONAMENTO
 KO 설치 시험 가동

1 2 3 4



1

2

3

4

- PL Ustaw kraj i język
 ES Fijar País e Idioma
 CHT 設定國家及語言
 PT Seleccione o País e Idioma
 KO 국가 및 언어 설정



- PL Sparuj optymalizatory mocy
 ES Emparejar los optimizadores
 CHT 配對功率優化器
 PT Emparelhar os Otimizadores
 KO 파워 옵티마이저

- PL Ustaw komunikację z platformą monitorowania i innymi falownikami
 ES Establecer comunicación con el portal de monitorización y con los otros inversores onduleus
 CHT 建立與監控平台及其他逆變器之通訊
 PT Ajustar comunicação com a Plata forma de Monitoramento e com os outros inversores
 KO 모니터링 플랫폼 및 다른 인버터 통신 설정

- PL Ustaw wszystkie pozostałe parametry
 ES Fijar los demás parametros
 CHT 設定其他參數
 PT Ajustar todos os outros parâmetros
 KO 다른 모든 파라미터 설정

11

- PL PRZEGLĄDANIE STATUSU SYSTEMU
- ES VISUALIZACIÓN ESTADO DEL SISTEMA
- CHT 查看系統狀態
- PT VISUALIZANDO STATUS DO SISTEMA
- KO 시스템 상태 표시



- PL Ustaw status ekranu
- ES Pantalla Estado SetApp
- CHT SetApp狀態介面
- PT Tela de Status do SetApp
- KO SetApp 상태 스크린

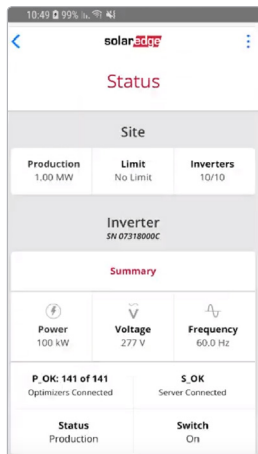



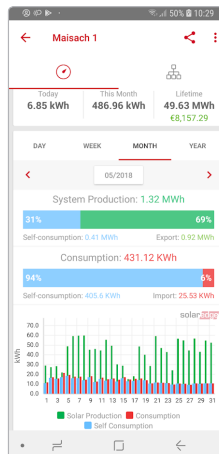



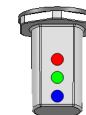

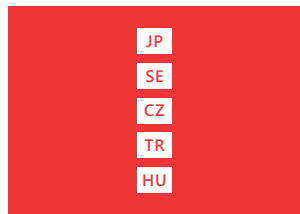

- PL Platforma monitorowania
- ES Portal de Monitorización
- CHT 監控系統
- PT Plataforma de Monitoramento
- KO 모니터링 플랫폼



- PL Wskazania LED
- ES Indicaciones LED
- CHR LED指示
- PT Indicações do LEDs
- KO LED 표시



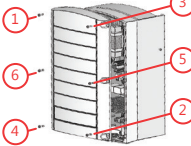

 <ul style="list-style-type: none"> JA 注意 SE OBS CZ POZNÁMKA TR NOT HU MEGJEGYZÉS 	 <ul style="list-style-type: none"> JA ケーブルコネクタを切断しないでください SE Klipp inte av kontakterna CZ Kably konektorů nestříhejte TR Kablo bağlantılarını kesmeyiniz. HU vágja el a kábelcsatlakozókat 	 <ul style="list-style-type: none"> AP 1. パワーコンディショナスイッチをオフ (0) にする 2. 安全スイッチをオフにする 3. ネジ (6本) を取り外す SE 1. Slå PÅ/AV till läget AV (0) 2. Vrid säkerhetsbrytaren till AV 3. Skruva upp de sex lockskruvarna CZ 1. Dejte vypínač ON/OFF do polohy OFF (0) 2. Dejte bezpečnostní vypínač do polohy OFF 3. Otevřete kryt uvolněním 6 šroubů TR 1. Kapatmak için AÇ/KAPA Anahtarını kapatınız (0) 2. Güvenlik Anahtarını KAPALI konuma getiriniz 3. Kapak Civatalarını Açınız HU 1. Kapcsolja KI (0) a KI-BE kapcsolót 2. Kapcsolja KI a biztonsági kapcsolót 3. Csavarozza ki a takarólap hat csavarját
 <ul style="list-style-type: none"> JA 分電盤交流ブレーカのON/OFF SE Slå PÅ/AV på huvudkretskortets AC-brytare CZ Zapnout/vypnout hlavní vypínač střídavého obvodu TR Ana devre AC anahtarını AÇ/KAPA HU Kapcsolja KI/BE a fő áramkör kapcsolóját 	 <ul style="list-style-type: none"> JP パワーコンディショナON/OFFスイッチ: 0=オフ; 1=オン SE Växelriktarens strömbrytare: 0=AV; 1=PÅ; P=Pairing/program CZ Vypínač střídače ON/OFF: 0=OFF; 1=ON P=Párování/Program TR Evirici AÇ/KAPA Anahtarını 0=KAPA; 1=AÇ HU Inverter KI-BE kapcsoló: 0 = KI; 1 = BE; P=Párosítás/Programozás 	
 <ul style="list-style-type: none"> JA 締め付けトルク SE Vridmomentvärde CZ Hodnota kroutícího momentu TR Tork değeri HU Nyomatékérték 	 <ul style="list-style-type: none"> JA DC安全スイッチ (DC安全ユニットのオープン) SE Säkerhetsbrytare (på ev. tillvald DC-säkerhetsenhet) CZ Bezpečnostní vypínač (na volitelné DC Safety Unit) TR Güvenlik Anahtarını (opsiyonel DC Güvenlik Birimi) HU Biztonsági kapcsoló (az opcionális DC biztonsági egységen) 	 <p>9.0 N*m / 6.6 ft.*lb 10.3 N*m / 7.6 ft.*lb (Plastic)</p> 
 <ul style="list-style-type: none"> JA LED SE lysdioder CZ LEDky TR LED'ler HU LED-ek 		<ul style="list-style-type: none"> JA ネジ (6本) を締める SE Skruva åt de sex lockskruvarna CZ Připevňte kryt 6 šrouby TR Kapak civatalarını kapatınız HU Csavarozza vissza a takarólap hat csavarját

1

- JA** パワーオプティマイザの設置
- SE** INSTALLERA EFFEKTOPTIMERARE
- CZ** INSTALACE VÝKONOVÝCH OPTIMIZÉRŮ
- TR** GÜÇ OPTİMİZÖRLERİNİN KURULUMU
- HU** A TELJESÍTMÉNY-OPTIMALIZÁLÓK TELEPÍTÉSE

1 2 3 4 5

- JA** デザイナーでストリング設計を確認
- SE** Verifiera strängdesignen med Designer
- CZ** Ověřte návrh stringů pomocí Designeru
- TR** Dizi tasarımını Designer ile doğrulayın
- HU** Ellenőrizze sztring terveket a Designer segítségével

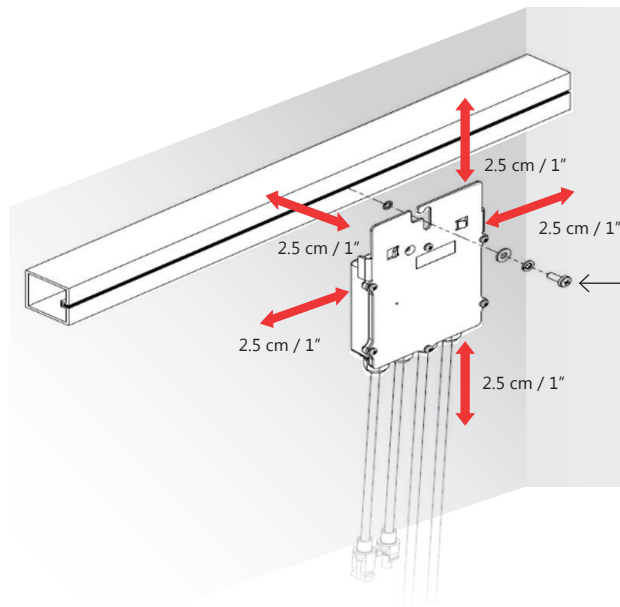

JA
M6/M8 ステンレススチール 9.5 N*m

SE
M6 (1/4") eller M8 (5/16")
rostfritt stål 9,5 N * m / 7 lb * ft

CZ
M6 (1/4") nebo M8 (5/16")
nerezová ocel 9,5 N*m / 7 lb*ft

TR
M6 (1/4") veya M8 (5/16")
paslanmaz çelik 9,5 N*m / 7 lb*ft

HU
M6 vagy M8 rozsdamentes acél 9,5 N*m

1

1 2 3 4 5

JA オプション A **CZ** MOŽNOST A **HU** A OPCIÓ
SE ALTERNATIV A **TR** A SEÇENEĞİ

JA QRコードステッカーを剥がす
SE Ta bort dekalerna
CZ Odlepte nálepky
TR Yapışkanları çıkarınız
HU Húzza le a matricákat

JA QRコードステッカーをスキャン
SE Skanna dekalarket
CZ Naskenujte štítek s nálepkami
TR Yapışkanlı kısmı tarayınız
HU Szkenelje be a matricás lapot

JA スキャン結果をSOLAREEDGEサポートに送信
SE E-posta till SolarEdge support
CZ Pošlete e-mail tech. podpoře SolarEdge
TR Taramayı SolarEdge destek birimine email olarak gönderiniz
HU Küldje el a SolarEdge ügyfélszolgálatához

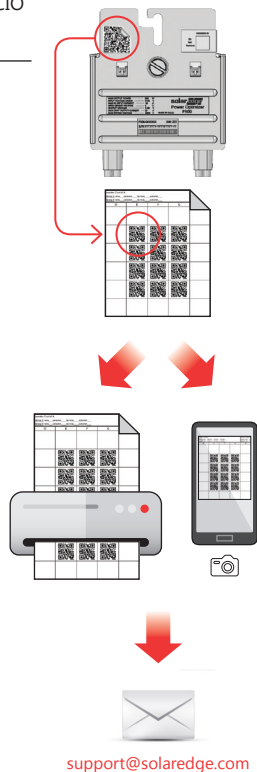

<http://www.solaredge.com/files/pdfs/physical-layout-template.pdf>

JA オプション B **CZ** MOŽNOST B **HU** B OPCIÓ
SE ALTERNATIV B **TR** B SEÇENEĞİ

JA SOLAREEDGEサイトマッパーを使用してQRコードをスキャン
SE Skanna dekalerna med appen SolarEdge site mapper
CZ Naskenujte nálepky pomocí aplikace Mapper
TR Yapışkanları SolarEdge sitesi eşleyicisi kullanarak tarayınız
HU Olvassa be a matricákat a Mapper appal

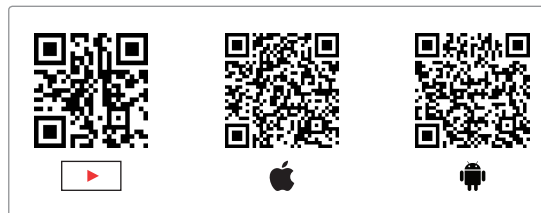

JA モニタリングプラットフォームでのサイト登録とレイアウトを完了
SE Färdigställ anläggningens registrering och fysiska layout i monitoreringsportalen
CZ Dokončete registraci instalace a fyzické rozvržení v monitorovací platformě
TR İzleme platformunda site kaydını ve fiziksel düzeni tamamlayınız
HU Véglegesítse a netes regisztrációt és fizikai kiosztás beállítását a monitoring platformon

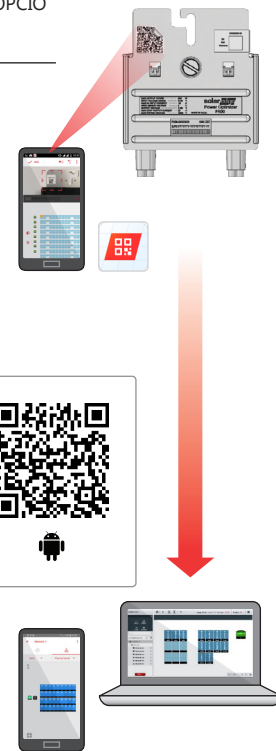

1

1 2 3 4 5

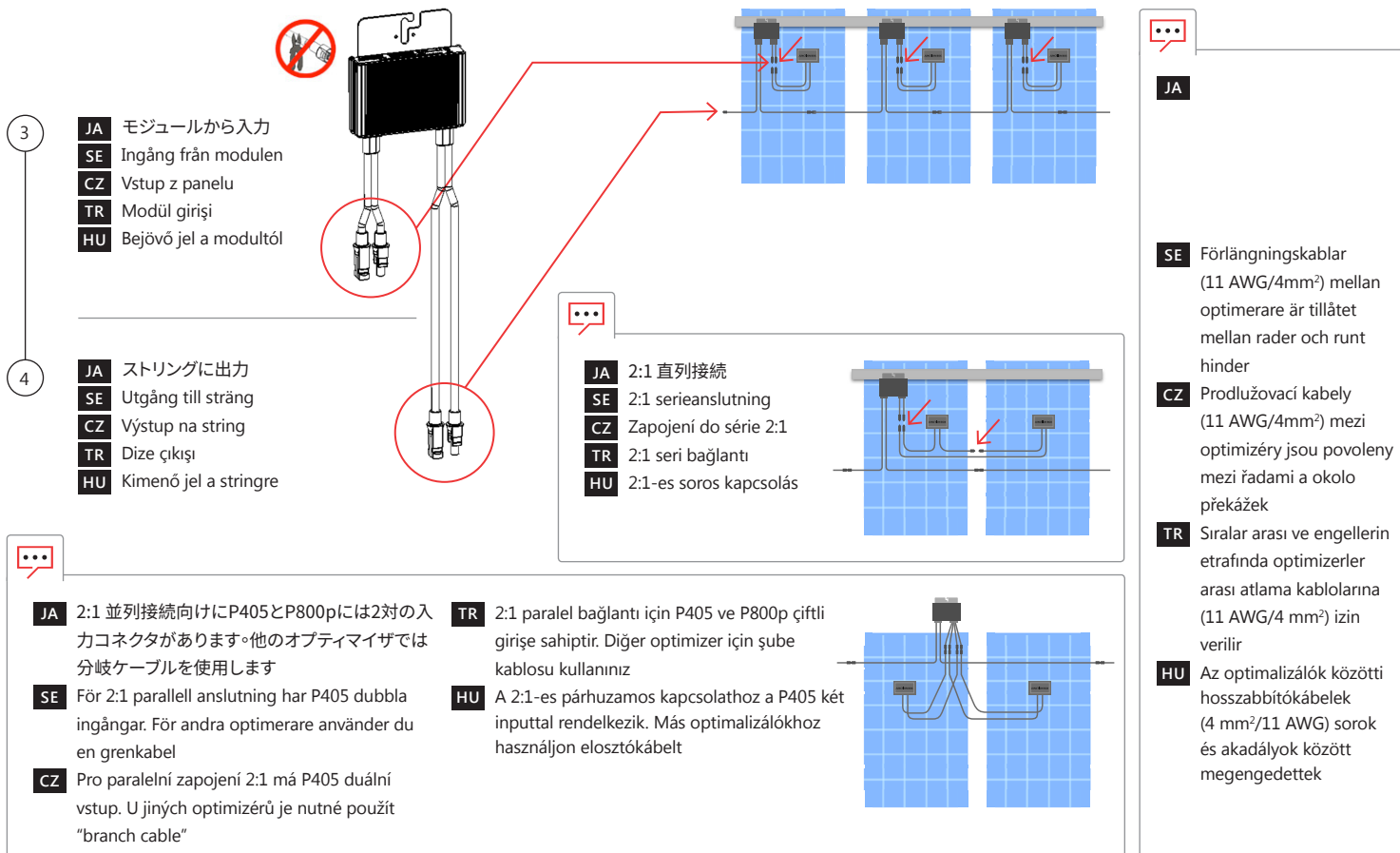

1

1 2 3 4 5

JA スtringの極性をチェックして各Stringの電圧を測定し、オプティマイザごとに1Vであることを確認します

SE Kontrollera strängspolariteten och mät spänningen i varje sträng för att verifiera $1\pm 0,1V$ per optimizer

CZ Zkontrolujte polaritu stringu a ověřte, že napětí každého stringu odpovídá $1\pm 0,1V$ na optimizér

TR Dize polaritesini kontrol ediniz ve her optimizer için $1\pm 0,1V$ olduğundan emin olmak için her dizinin gerilimini ölçünüz

HU Ellenőrizze a sztringek polaritását, és hogy minden egyes sztringen valóban $1\pm 0,1V$ feszültség van-e optimalizálónként

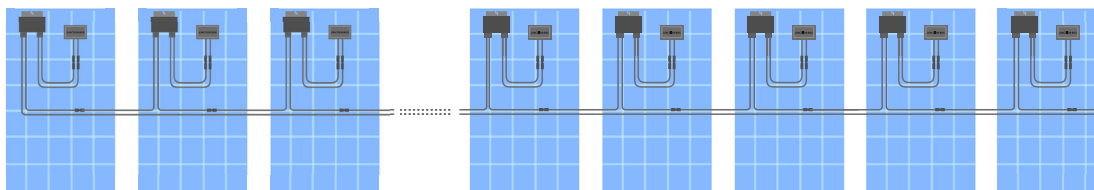

- JA** 例: 16 オプティマイザ = ~16V
SE Exempel: 16 effektoptimerare = ~ 16V
CZ Příklad: 16 optimizérů = ~16V
TR Örnek: 16 optimizer = ~16 V
HU Például: 16 optimalizáló = ~16V

2

- JA パワーコンディショナの設置
 SE INSTALLERA VÄXELRIKTAREN
 CZ INSTALACE STRÍDAČE
 TR EVIRICI KURULUMU
 HU AZ INVERTER TELEPÍTÉSE

1

2

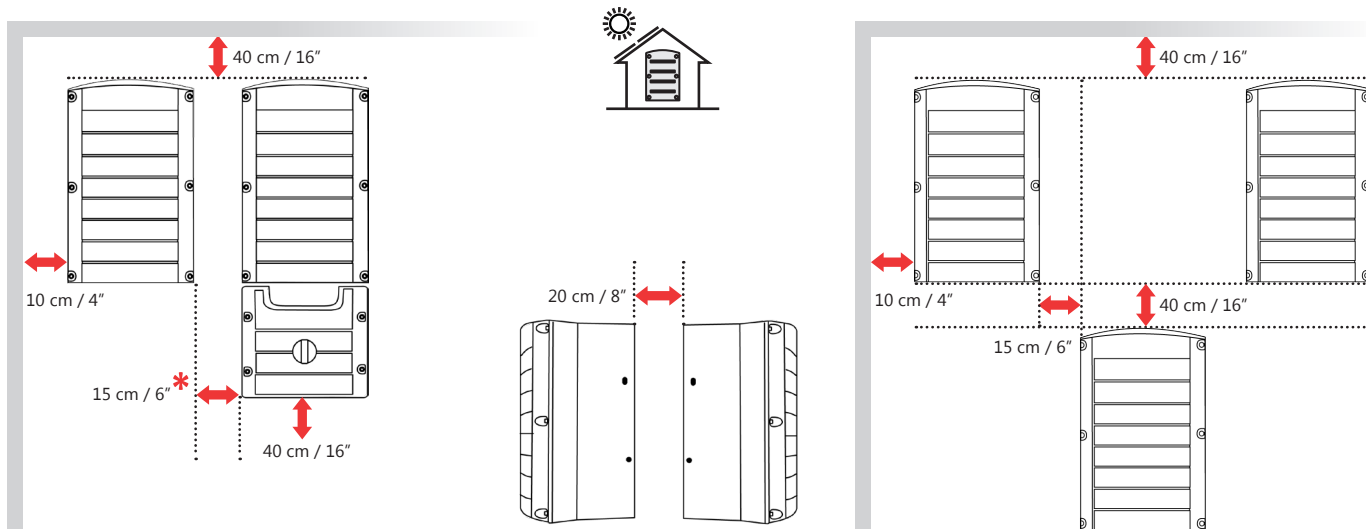

- JA * 20 cm / 8" 日次最高気温の平均が 25°C を上回る場合
 SE * 20 cm / 8" där den årliga genomsnittliga högsta temperaturen är under 25°C / 77°F
 CZ * 20 cm / 8" kde je průměrná nejvyšší roční teplota pod 25°C / 77°F
 TR * 20 cm / 8" ortalama en yüksek sıcaklığın 25°C / 77°F altındaysa
 HU * 20 cm / 8" ahol az éves maximális középhőmérséklet 25 °C felett van

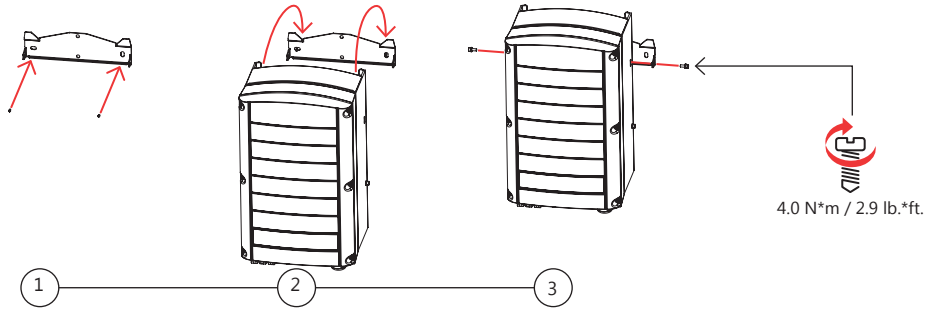
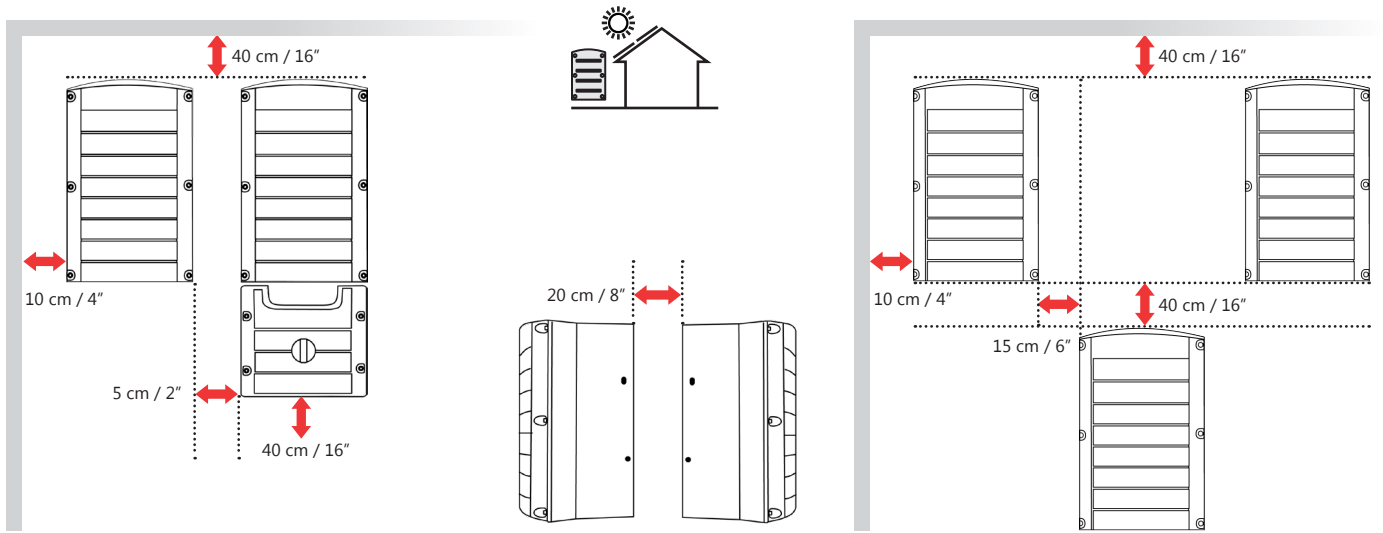

3

- JA** スtringとパワーコンディショナの接続
- SE** ANSLUTNING AV STRÄNGARNA TILL VÄXELRIKTAREN
- CZ** PŘIPOJOVÁNÍ STRINGŮ KE STŘÍDAČI
- TR** DİZELERİN EVİRİCİYE BAĞLANMASI
- HU** SZTRINGEK CSATLAKOZTATÁSA AZ INVERTERHEZ

1 2

1

- JA** 1-3 MC4 ペア (モデルにより異なる)
- SE** 1-3 MC4 par, modellberoende
- CZ** 1-3 páry MC4, podle modelu
- TR** 1-3 MC4 çiftleri, model bağımlı
- HU** 1-3 MC4-pár, modellfüggő

**JA**

- SE** För ytterligare strängar parallellkopplade använd extern kopplingsbox eller grenkablar
- CZ** Pro dodatečné paralelní stringy použijte externí sružovací box nebo "branch cable"
- TR** Paralelde ekstra dizi kullanılacaksa, harici toplama kutusu veya şube kablosu kullanın
- HU** Kiegészítő sztringek párhuzamos kapcsolásához használjon külső közösítő dobozt vagy elosztó kábelt

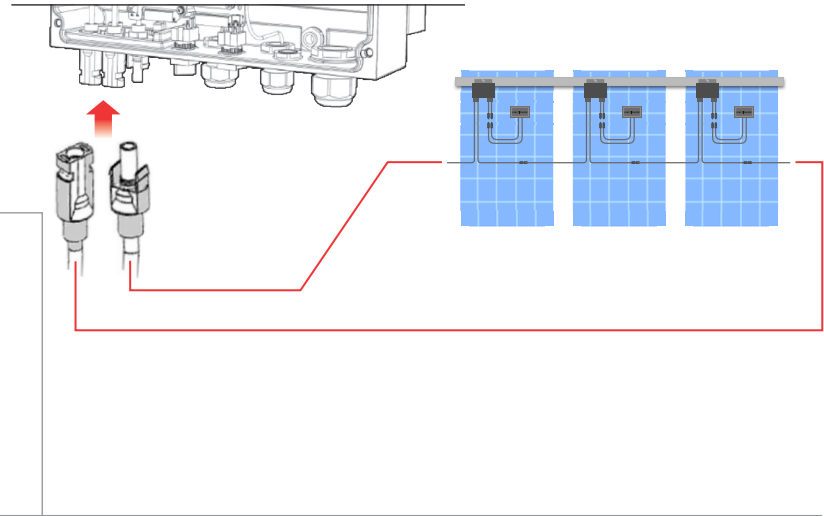

2

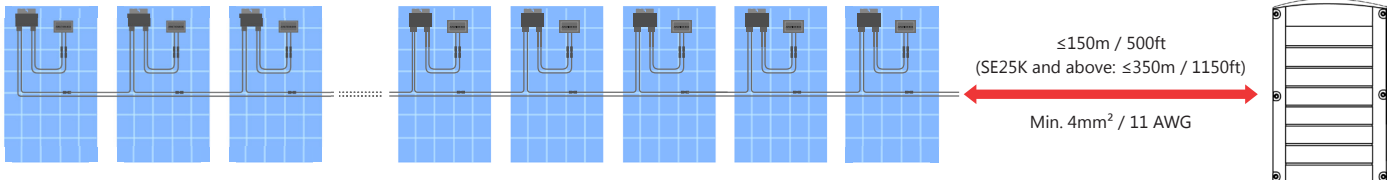

4

- JA** 電源とパワーコンディショナの接続
- SE** ANSLUTNING AV AC TILL VÄXELRIKTAREN
- CZ** PŘIPOJOVÁNÍ AC STRANY STŘÍDAČE
- TR** AC'NİN EVİRİCİYE BAĞLANMASI
- HU** AZ INVERTER RÁKAPCSOLÁSA A HÁLÓZATRA

1 2 3

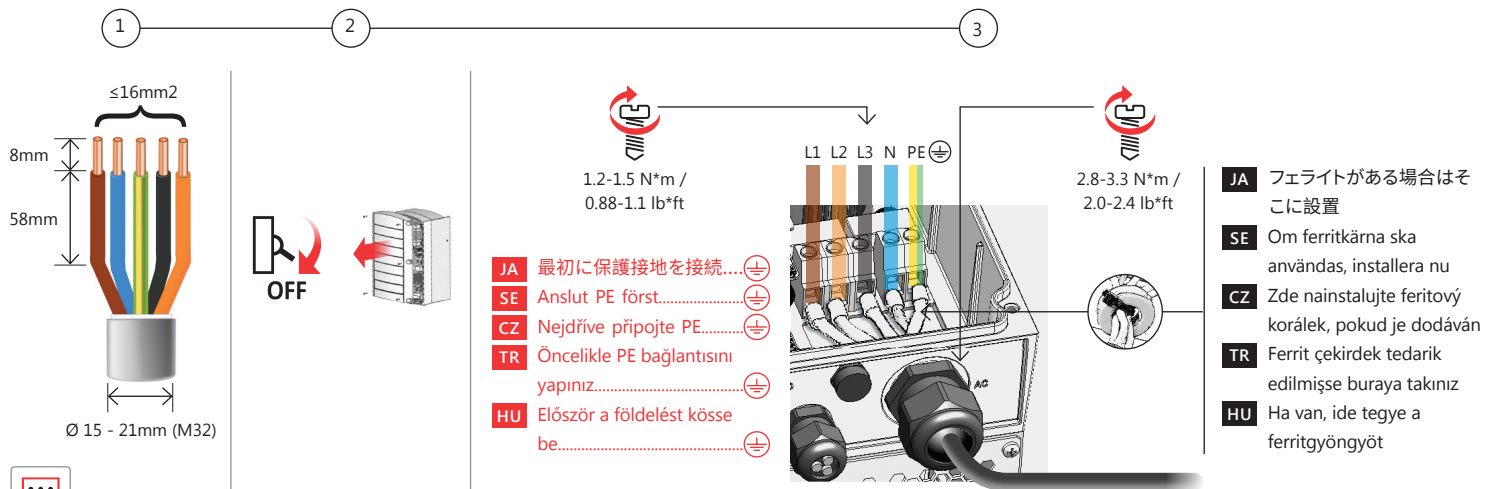

JA 注意
一部の国ではデルタグリッドに接続できるパワーコンディショナもあります。詳しくはQRコードをスキャンしてください

SE OBS!
Vissa växelriktare kan i vissa länder anslutas till deltanät. Skanna för att läsa mer

CZ Poznámka
některé střídače v některých zemích se mohou připojovat k el. sítím "delta". Skenujte pro více informací

TR NOT
Bazı ülkelerde bazı eviricilerin dörtlü sisteme bağlanması gerekebilir. Daha fazla bilgi için okutunuz

HU MEGJEGYZÉS
bizonyos invertereket egyes országokban delta hálózatra lehet kapcsolni. Olvassa be a kódot a továbbiakért



EN



FR









NL

5

- JA** 通信の設定
- SE** STÄLL IN KOMMUNIKATION
- CZ** NASTAVENÍ KOMUNIKACE
- TR** HABERLEŞME KURULUMU
- HU** KOMMUNIKÁCIÓS EGYSÉG BEÁLLÍTÁSA

JA 内蔵: 1. イーサネット p. 52 2. RS485 p. 54	SE Inbyggd: 1. Ethernet p. 52 2. RS485 p. 54	CZ Vestavěno: 1. Ethernet p. 52 2. RS485 p. 54	TR Dahili: 1. Ethernet p. 52 2. RS485 p. 54	HU Beépített: 1. Ethernet p. 52 2. RS485 p. 54
--	---	---	--	---

JA 任意	ES Tillval	CZ Volitelné	TR Opsiyonel	HU Nem tartozék		
	JA アンテナが必要	SE Kräver antenn	CZ Je vyžadována anténa	TR Anten gereklidir	HU Antenna szükséges	 EN
	JA ZigBeeプラグイン	SE ZigBee Plug-in	CZ ZigBee zásuvný modul	TR ZigBee Plug-in	HU ZigBee Plug-in	 EN
	JA WCDMAプラグイン	SE GSM-plugin	CZ Mobilní (cellular) plug-in	TR Takılıp Çıkartılabilir GSM	HU Mobilhálózati (cellular) bővítőmodul	 EN

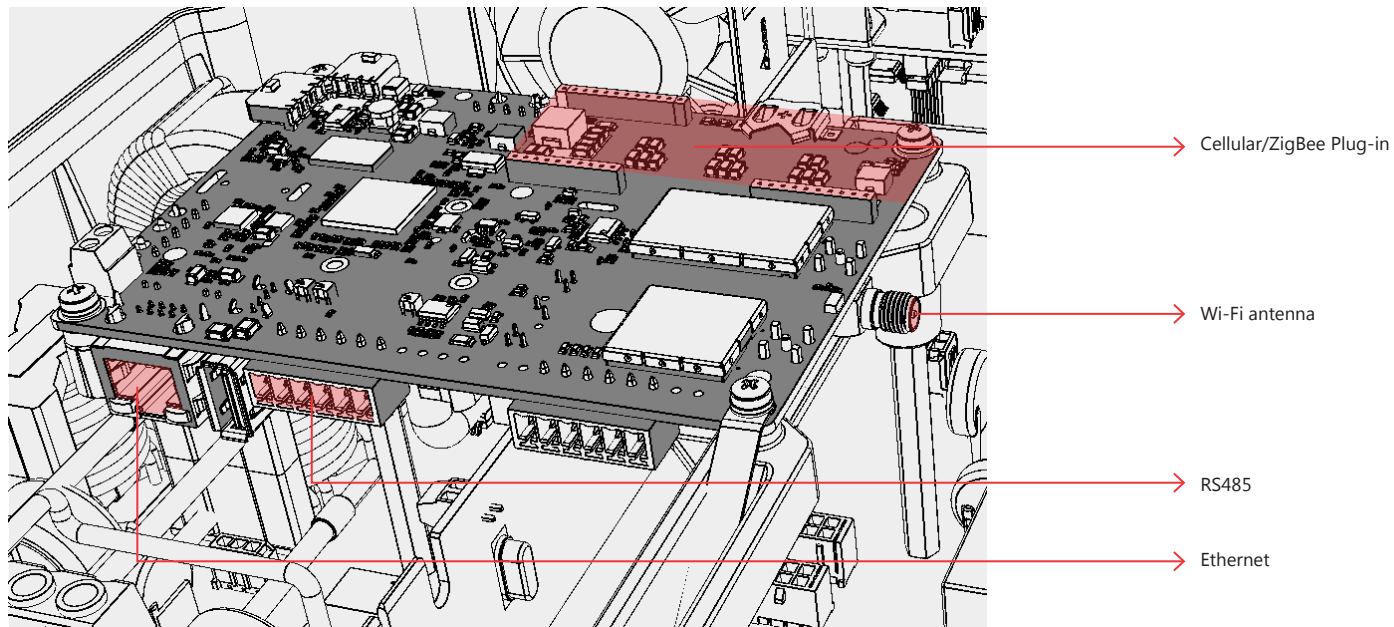

- JA** トラブルシューティング
- SE** För felsökning
- CZ** Pro řešení problémů
- TR** Sorun giderme
- HU** Ha problémát észlel



- JA** アプリケーションノート: 通信オプション
- SE** Tillämpningsanteckning: Kommunikationsalternativ
- CZ** Návod k aplikaci: Komunikační možnosti
- TR** Uygulama notu: Haberleşme Seçenekleri
- HU** Részletes tudnivalók a kommunikációs egységekről



6

- JA イーサネット (LAN) 接続の確立
- SE SKAPA EN ETHERNET-ANSLUTNING (LAN)
- CZ VYTVOŘENÍ ETHERNETOVÉHO (LAN) PŘIPOJENÍ
- TR ETHERNET (LAN) BAĞLANTISI OLUŞTURMA
- HU ETHERNET (LAN) KAPCSOLAT LÉTREHOZÁSA

1 2 3 4

1

2

3

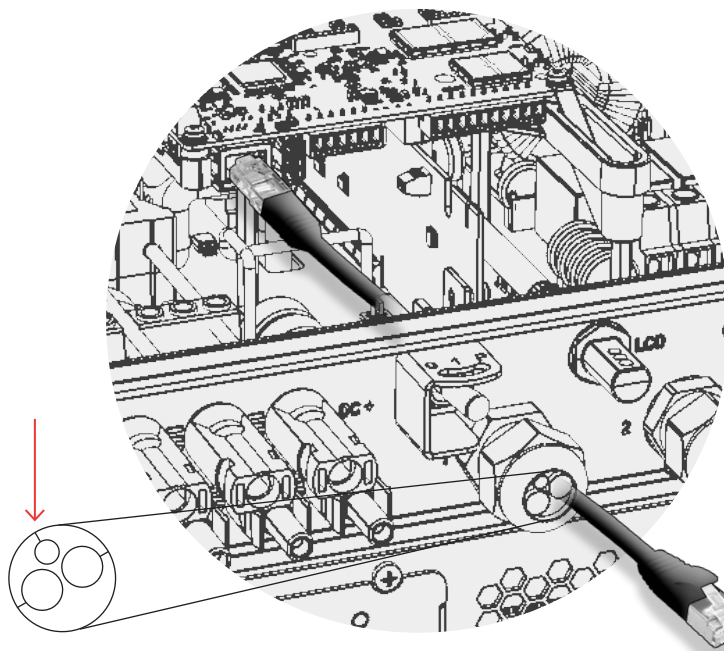
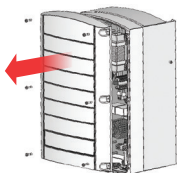

- JA イーサネットルータ
- SE Ethernet-router
- CZ Ethernetový směrovač
- TR Ethernet Yönlendirici
- HU Ethernet router

JA

RJ45 のピン 番号	芯の色 ¹		10Base-TX シグナル
	T568B	T568A	100Base-TX シグナル
1	白/オレンジ	白/緑	送信+
2	オレンジ	緑	送信-
3	白/緑	白/オレンジ	受信+
4	青	青	リザーブ
5	白/青	白/青	リザーブ
6	緑	オレンジ	受信-
7	白/茶	白/茶	リザーブ
8	茶	茶	リザーブ

CZ

Pino RJ45 #	Barva drátu ¹		10Base-TX Signal
	T568B	T568A	100Base-TX Signal
1	Bílý/Oranžový	Bílý/Zelený	Transmit+
2	Oranžový	Zelený	Transmit-
3	Bílý/Zelený	Bílý/Oranžový	Receive+
4	Modrý	Modrý	Reserved
5	Bílý/Modrý	Bílý/Modrý	Reserved
6	Zelený	Oranžový	Received-
7	Bílý/Hnědý	Bílý/Hnědý	Reserved
8	Hnědý	Hnědý	Reserved

HU

Pino RJ45 #	Az erek színe ¹		10Base-TX Signal
	T568B	T568A	100Base-TX Signal
1	fehér/narancs	fehér/zöld	adás+
2	narancs	zöld	adás-
3	fehér/zöld	fehér/narancs	vétel+
4	kék	kék	fenntartott
5	fehér/kék	fehér/kék	fenntartott
6	zöld	narancs	vétel-
7	fehér/barna	fehér/barna	fenntartott
8	barna	barna	fenntartott

SE

RJ45 Pin #	Kabelfärg ¹		10Base-TX Signal
	T568B	T568A	100Base-TX Signal
1	Vit / Orange	Vit / Grön	Skicka+
2	Orange	Grön	Skicka-
3	Vit / Grön	Vit / Orange	Mottag+
4	Blå	Blå	Reserverad
5	Vit / Blå	Vit / Blå	Reserverad
6	Grön	Orange	Mottagen-
7	Vit / Brun	Vit / Brun	Reserverad
8	Brun	Brun	Reserverad

TR

RJ45 girişleri #	Tel rengi ¹		10Baz-TX Sinyal
	T568B	T568A	100Baz-TX Sinyal
1	Beyaz/Turuncu	Beyaz/Yeşil	İlet+
2	Turuncu	Yeşil	İlet-
3	Beyaz/Yeşil	Beyaz/Turuncu	Al+
4	Mavi	Mavi	Rezerve
5	Beyaz/Mavi	Beyaz/Mavi	Ayrıldı
6	Yeşil	Turuncu	Alındı-
7	Beyaz/Kahverengi	Beyaz/Kahverengi	Rezerve
8	Kahverengi	Kahverengi	Rezerve

JA ¹パワーコンディショナはRX/TX極性の変更をサポートしていません。イーサネットクロスオーバーケーブルへの対応はスイッチに依存します

SE ¹Växelriktarens anslutning stöder inte Rx/Tx polaritet. Stödjande Ethernet-kabelövergångar beror på switchfunktionerna

CZ ¹Připojení střídače nepodporuje změnu polarity RX/ TX. Podpora křížených ethernetových kabelů závisí na možnostech přepínače

TR ¹Evirici bağlantısı RX/TX polarite değişikliğini desteklemiyor. Ethernet kablo atlamalarının desteklenmesi anahtar niteliğine bağlıdır

HU ¹Az inverter nem támogatja az adás-vétel (TX/RX) polaritás felcserélését. Az Ethernet-keresztkábel támogatása a switch lehetőségeitől függ

7

- JA** RS485バス接続の確立
- SE** SKAPA EN RS485-BUSSANSLUTNING
- CZ** PŘIPOJENÍ NA SBĚRNICI RS485
- TR** RS485 VERİ YOLU BAĞLANTISI KURUN
- HU** RS485-ÖS BUSZKAPCSOLAT KIÉPÍTÉSE

1

2

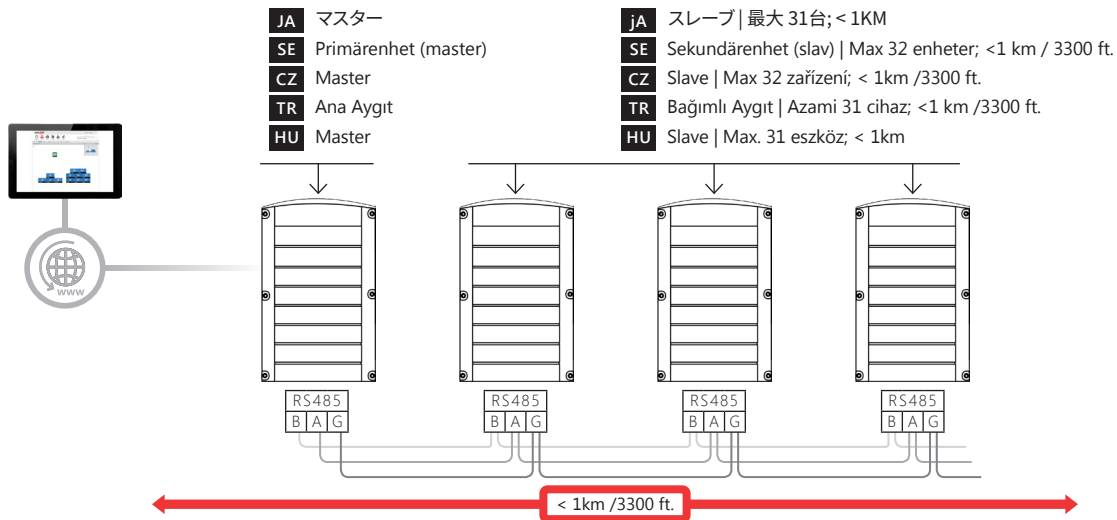

JA 最低3芯のシールド付きツイステッドペアケーブル(4芯ケーブルの使用可) 線の横断面: 0.2-0.5MM²(CAT5ケーブルを使用可)

SE Min. 3-tråds- avskärat tvinnat par (en 4-trådig kabel kan användas) Ledartvärsnitt: 0,2-1 mm² / 24-18 AWG (en CAT5-kabel kan användas)

CZ Kroucená dvoulinka - min. 3 stíněné páry (může být použit kabel se 4 páry) Průřez vodiče: 0,2-1 mm² / 24-18 AWG (může být použit kabel CAT5)

TR Asgari 3 telli çift bükümlü ekranlı kablo (4 telli kablo kullanılabilir) Tel kesiti: 0,2-1 mm² / 24-18 AWG (CAT5 kablo kullanılabilir)

HU Legalább háromeres, szigetelt, csavart érpár (négyeres kábel is használható) A kábel átmérője: 0,2–1 mm² / 24–18 AWG (CAT5-ös kábel is használható)

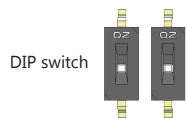

JA RS485接続両端パワーコンディショナの終端: SW1 DIP スイッチ (左側のスイッチ) を上げる

SE Avsluta första och sista enheter: Flytta upp SW1 DIP-omkopplare (vänster brytare)

CZ Ukončete první a poslední zařízení: SW1 DIP přepínač dejte nahoru (levý přepínač)

TR İlk ve son cihazları sonlandır: SW1 DIP anahtarını yukarı kaldırın (sol anahtar)

HU Első és utolsó eszköz zárolása: mozdítsa felfelé az SW1 DIP-kapcsolót (bal oldali kapcsoló)

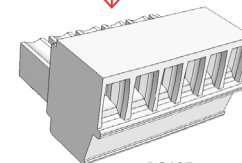
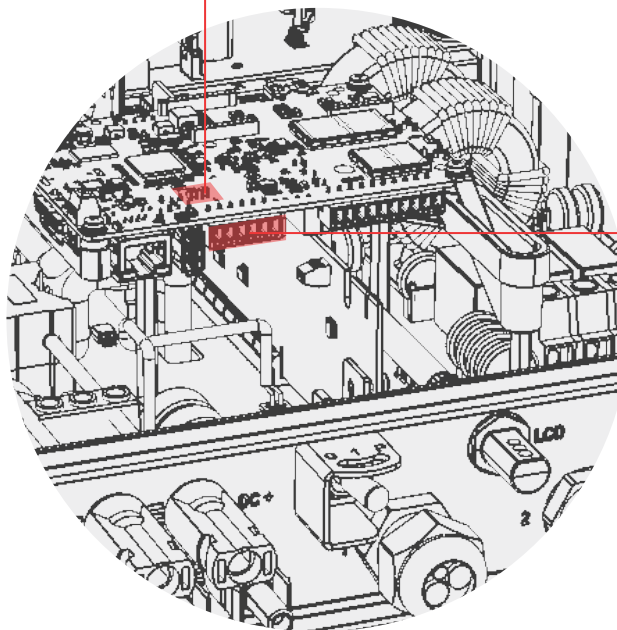



■ パ

SE 1:A DRIFTSÄTTNING MED SETAPP

CZ PRVOTNÍ INSTALACE SETAPP

TR İLK DEFA SETAPP KURULUMU

Hu SETAPP TELEPÍTÉS ELSŐ ALKALOMMAL

1 — 2



JA

SE **Login:**

1. Öppna SetApp och följ instruktionerna
2. Logga in med samma anv.uppg. som för monitoreringsportal

CZ

Přihlášení:

1. Otevřete SetApp a následujte instrukce
2. Přihlašte se pomocí jména a hesla pro monitoring

TR

Kayıt:

1. SetApp'ı açın ve yönlendirmeleri takip edin
2. Abırir SetApp e seguir instruções

HU

Bejelentkezés:

1. Nyissa meg a SetApp alkalmazást, és kövesse az utasításokat
2. Jelentkezzen be a monitorozó felhasználónevével és jelszavával

9

- パ
- SE AKTIVERING
- CZ AKTIVACE
- TR AKTIVE OLUYOR
- HU AKTIVÁLÁS

1 2



■ JA

■ SE Skanna växelriktarens QR-kod; för RS485-bus, skanna masterenheten först

■ CZ

Naskenujte QR kód střídače; pro sběrnici RS485 naskenujte nejdříve master

■ TR

RS485 veriyolu, öncelikle ana bilgisayardan tara

■ HU

Olvassa be az inverter QR kódját; RS485-ös bus használatakor, kezdje a master inverterrel

■ JA

■ SE Följ anvisningar i SetApp

■ CZ Následujte instrukce SetApp

■ TR SetApp yönlendirmelerini takip et

■ HU Kövesse a SetApp utasításokat



■ JA

■ SE SetApp upprättar en wifi-anslutning med växelriktaren

■ CZ

SetApp vytvoří Wi-Fi spojení s měničem

■ TR

SetApp evirici ile bir kablosuz ağ kuruyor

■ HU

A SetApp Wi-Fi kapcsolatot hoz létre az inverterrel

10

JA パ

SE DRIFTSÄTTNING

CZ SPUŠTĚNÍ INSTALACE

TR KURULUM GERÇEKLEŞTIRILMESI

HU AKTIVÁLÁS

1 2 3 4



1

2

3

4

JA

SE Välj land och språk

CZ Nastavte zemi a jazyk

TR Ülkeyi ve dili ayarla

HU Állítsa be az országot és a nyelvet

JA

SE Para optimerarna

CZ Napárujte výkonové optimalizéry

TR Optimizerleri eşleştir

HU Párosítsa a teljesítmény optimalizálókat



JA

SE Ställ kommunikation för monitore ringsportal och ev andra växelriktare

CZ Nastavte komunikaci k monitorovací platformě a dalším měničům

TR İzleme sistemi ve diğer eviricilerle ile haberleşmeyi kur

HU Állítsa be a kommunikációt a monitorozó platformra és a többi inverterre

JA

SE Ställ ev. andra inställningar

CZ Nastavte všechny ostatní parametry

TR Diğer ayarları kur

HU Állítsa be az összes többi paramétert

11

JA パ

SE SE SYSTEMSTATUS

CZ ZOBRAZENÍ STAVU SYSTÉMU

TR SİSTEM DURUMUNU GÖRÜNTELEME

HU A RENDSZER ÁLLAPOT MEGTEKINTÉSE



JA

SE SetApp statusskärm

CZ Stavová obrazovka SetApp

TR SetApp Durum ekranı

HU SetApp állapot képernyő

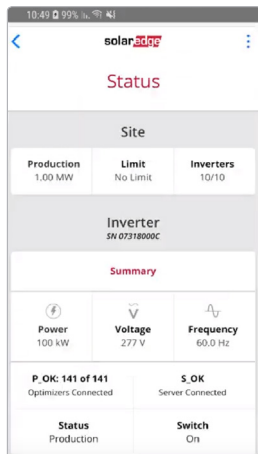

JA

SE Monitoreringsportal

CZ Monitorovací platforma

TR İzleme sistemi

HU Monitorozó platform

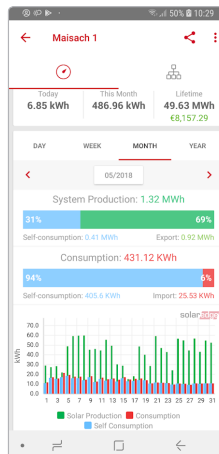

JA

SE LED-indikering

CZ Indikace LED

TR LED göstergeleri

HU LED jelzések

